

MESA/BOOGIE

DUAL & TRIPLE

Rectifier[®]

SOLO HEADS

Owner's Manual

Hello from the Tone Farm

...You, smart player and all around intuitive human, have put your trust in us to be your amplifier company. This is something we do not take lightly. By purchasing and choosing this unit to be a part of your musical voice, you have become part of the Mesa family...WELCOME! Our goal is to never let you down. Your reward is that you are now the owner of a great amp, bred of fine all tube amp heritage...benefiting from the many pioneering and patented Mesa circuits that led to the refinement of your new instrument. Feel confident, as we do, this amp will inspire many hours of musical satisfaction and lasting enjoyment. It was built with you in mind, by players who know the value of a fine musical instrument and the commitment it takes to make great music. The same commitment to quality, value and support we make to you...our new friend.

DUAL & TRIPLE RECTIFIER SOLO HEADS

TABLE OF CONTENTS

Precautions

OVERVIEW & INSTANT GRATIFICATION _____ 1

FRONT PANEL CONTROLS

POWER-UP _____ 2

GAIN / TREBLE / MIDDLE _____ 3/4

BASS / PRESENCE _____ 5

MASTER and LOOP ACTIVE MASTER _____ 6

TOGGLE SWITCHES:

POWER / ON and ON / STANDBY _____ 7

REAR PANEL CONTROLS, SWITCHES & JACKS

OVERVIEW _____ 8

FUSE _____ 8

RECTIFIER SELECT _____ 8/9

BIAS SWITCH _____ 9

FX - Send & Return _____ 9

SEND LEVEL CONTROL _____ 10

LOOP SELECT ROTARY CONTROL _____ 10

SLAVE LEVEL CONTROL _____ 10

SPEAKERS _____ 10/11

EXTERNAL SWITCH JACKS _____ 11

CHANNEL STYLE SELECT _____ 11

CHANNEL SELECT _____ 11

FACTORY SAMPLE SETTINGS _____ 12

PERSONAL SETTINGS SHEET _____ 13

TUBE DESCRIPTION & TASK CHARTS _____ 14/15

TUBE NOISE & MICROPHONICS _____ 16

DIAGNOSING PRE-AMP TUBE PROBLEMS _____ 17

BIAS ADJUSTMENT: A feature article by Randall Smith _____ 18/20

SPEAKER IMPEDANCE 7 POSSIBLE HOOK-UP SCHEMES - Amplifier to Speaker Cabs _____ 21/26

TRIODES, PENTODES & IRISHMEN: A feature article on the workings of tubes _____ 27/29

PART SHEETS _____ 30/31

PRECAUTIONS & WARNINGS

Your MESA/Boogie Amplifier is a professional instrument. Please treat it with respect and operate it properly.

USE COMMON SENSE AND ALWAYS OBSERVE THESE PRECAUTIONS:

WARNING: EU: permission from the Supply Authority is needed before connection.

WARNING: Vacuum tube amplifiers generate heat. To insure proper ventilation always make certain there is at least four inches (100mm) of space behind the rear of the amplifier cabinet. Keep away from curtains or any flammable objects.

WARNING: Do not block any ventilation openings on the rear or top of the amplifier. Do not impede ventilation by placing objects on top of the amplifier which extend past the rear edge of its cabinet.

WARNING: Do not expose the amplifier to rain, moisture, dripping or splashing water. Do not place objects filled with liquids on or nearby the amplifier.

WARNING: Always make certain proper load is connected before operating the amplifier. Failure to do so could pose a shock hazard and may result in damage to the amplifier.

Do not expose amplifier to direct sunlight or extremely high temperatures.

Always insure that amplifier is properly grounded. Always unplug AC power cord before changing fuse or any tubes. When replacing fuse, use only same type and rating.

Avoid direct contact with heated tubes. Keep amplifier away from children.

Be sure to connect to an AC power supply that meets the power supply specifications listed on the rear of the unit. Remove the power plug from the AC mains socket if the unit is to be stored for an extended period of time. If there is any danger of lightning occurring nearby, remove the power plug from the wall socket in advance.

To avoid damaging your speakers and other playback equipment, turn off the power of all related equipment before making the connections.

Do not use excessive force in handling control buttons, switches and controls. Do not use solvents such as benzene or paint thinner to clean the unit. Wipe off the exterior with soft cloth.

Be sure to have the warranty card filled out by the store at which it was purchased and return to *Mesa/Boogie*.

YOUR AMPLIFIER IS LOUD! EXPOSURE TO HIGH SOUND VOLUMES MAY CAUSE PERMANENT HEARING DAMAGE !

No user serviceable parts inside. Refer service to qualified personnel. Always unplug AC power before removing chassis.

EXPORT MODELS: Always insure that unit is wired for proper voltage. Make certain grounding conforms with local standards.

READ AND FOLLOW INSTRUCTIONS OF PROPER USAGE.

DUAL & TRIPLE RECTIFIER SOLO HEADS

Operating Instructions

Congratulations for choosing either the **DUAL** or **TRIPLE RECTIFIER** Solo Head. You have purchased a handbuilt instrument of the finest quality and craftsmanship. A unique blend of yesteryear's black magic power section design combined with our race-shop approach to finely tuned, high gain pre-amp circuitry leaves both of these amps standing alone...instantly classics and destined for vintage status. With two channels housing three definitive and distinctly different Modes, a complete array of supremely dialed guitar sounds can be obtained quickly and easily. Add to this Patented Switchable Rectifiers (Tube/Silicon Diode,) and Channel Style Select, a hard Bypassable / Channel Assignable FX Loop, Spongy / Bold AC. Power, Reverb and you've got the most performance packed, bodacious self contained guitar amp ever. And if all these features don't tell the truth about the **DUAL** or **TRIPLE RECTIFIER** Solo Head...how about the on board Bias switch that enables you to use either 6L6 or EL34 power tubes. Customize this dynamic power section for the tube style that fits your music best!

Looking to the Rear Panel assures that all your interfacing needs are covered. A Parallel Effects Loop with a Mix control provides tone insurance for even those questionable effects. To use either of these two **RECTIFIER** Solo Heads in larger rack systems, or to interface to other power sections, the Slave Jack and Level control is a welcome feature. Three speaker jack combinations have been provided...two 4 Ohm, one 8 Ohm and one 16 Ohm - to ensure the proper impedance match to many types of speaker enclosures. The other features will prove to be quite valuable to you and further along in this manual they are covered extensively.

Below are illustrations of the **TRIPLE RECTIFIER** Solo Head - the **DUAL RECTIFIER** Solo Head has the identical Front and Rear Panel layout and features. Therefore, we will be using the illustration of the **TRIPLE RECTIFIER** Solo Head throughout this owner's manual in regards to identifying and explaining the various on board features and controls.

First familiarize yourself with the layout of the Front Panel and locate the Footswitch Input jack. This jack, when connected to your footswitch will allow you to select either the Lead or Rhythm channel remotely. The Rear Panel Channel Select toggle must be in the

FRONT VIEW : **DUAL or TRIPLE RECTIFIER** Solo Head

Instant Gratification Demo Settings

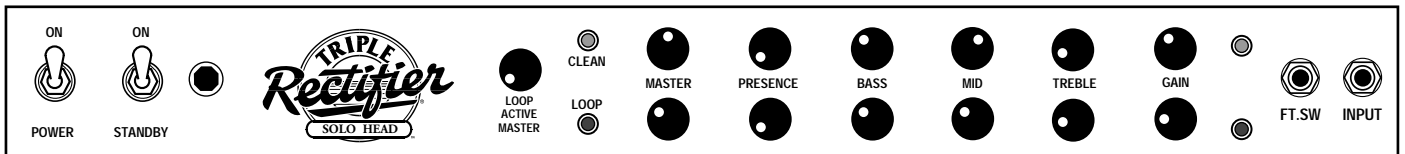

REAR VIEW : **DUAL or TRIPLE RECTIFIER** Solo Head

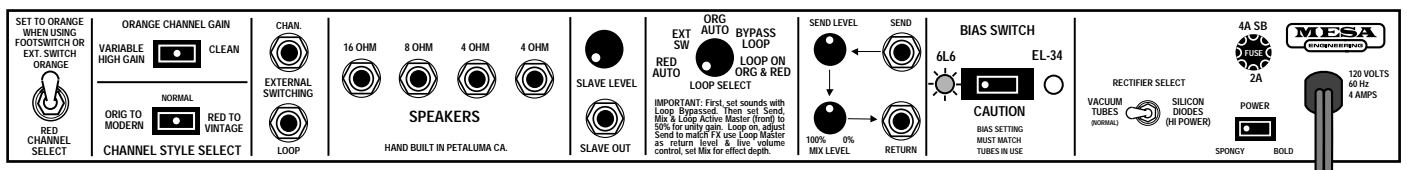

FRONT PANEL:

UP position (Orange.) If you don't have a footswitch available, the Channel Switch located on the Rear Panel (far left end of panel if facing front of amp) will activate this switching procedure. Before we get intimate with each control, let's audition the two channels with a basic clean setting in the Vintage Orange (Rhythm Channel) and a fairly high gain overdriven sound in the Modern Red (Lead Channel.)

POWER-UP: First remove the protective covers from the tubes (plastic webbing) before connecting the AC. cord to a power receptacle. Connect your favorite guitar to the instrument Input jack. Flip the POWER switch ON while leaving the STANDBY switch set to STANDBY. (It is always a good idea to practice this start up procedure as at least 30 seconds of warm-up time lessens the shock on cold power tubes, thus prolonging their life substantially.) Next, using the example below as a guide, set the controls as illustrated and flip the STANDBY switch to the ON position to listen to the two distinctly different channels using either the footswitch or the Channel Select toggle switch as mentioned in the paragraph above.

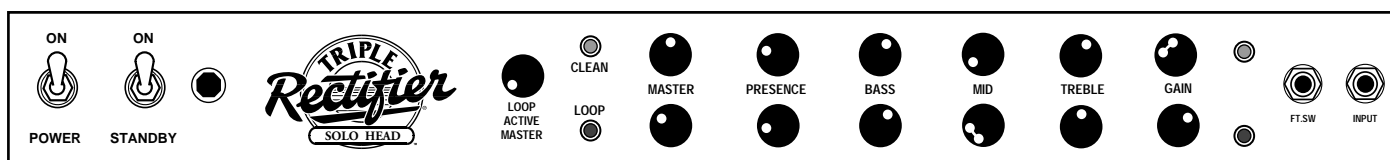

FRONT PANELS ARE THE SAME FOR BOTH DUAL & TRIPLE RECTIFIER SOLO HEADS

The above settings are merely examples of the channels, Vintage Orange and Modern Red. These two channels are voiced very differently when the Channel Cloning (TM) switch, located on the left side of the Rear Panel, (when viewing from the rear) is set to NORMAL. The Modes are selected using the toggle switch located on the Rear Panel far left side. Orange is the softer, sweeter of the two channels and houses two Modes of operation Clean and Vintage High Gain. The Modern Red channel boasts two Modes also and these are labeled Blues and Modern High Gain.

NOTE: It is normal to hear a volume level difference when switching from Clean to Variable High Gain. This difference will get larger as the MASTER Volume is increased and the amp is played loud.

Since all the Modes are extremely useful and versatile, they may all be considered as Variable High Gain Modes with Clean being the obvious lower gain of the four. We encourage experimentation as the names we have given each of the Modes refers more to a region of gain than to a stylistic boundary.

The **DUAL** and **TRIPLE RECTIFIER** Solo Heads are extremely versatile and the amazing sounds of even one of the Modes many times left us with the desire to have two of the same channels. This would allow a player to have two of the same Modes with just different settings. That way a player could use, say, the Orange (Vintage High Gain) for a crunch rhythm sound and switch to virtually that same sound with maybe a touch less Treble or a pinch more Gain and a higher Master setting for soloing. Or, maybe one might want to use the Clean Mode in the Orange channel, yet want the Variable High Gain Mode in the Orange channel for a different type of blues solo sound. This type of wish listing the channel configuration eventually led to the concept of Channel Cloning (TM.) Since the switch for this feature is located on the Rear Panel, we will review it later in the manual under Rear Panel.

Now that you've heard the either the **DUAL** or **TRIPLE RECTIFIER** Solo Heads two channels, let's move on to understanding the controls and their interactive roles in achieving the sounds that you want to hear.

CONTROLS:

GAIN: Like most amplifiers, the **GAIN** Control in each channel determines its sensitivity and overall tonal characteristics. It meters the amount of Gain (volume) that your guitar signal will produce. In both the *DUAL* and *TRIPLE RECTIFIER* Solo

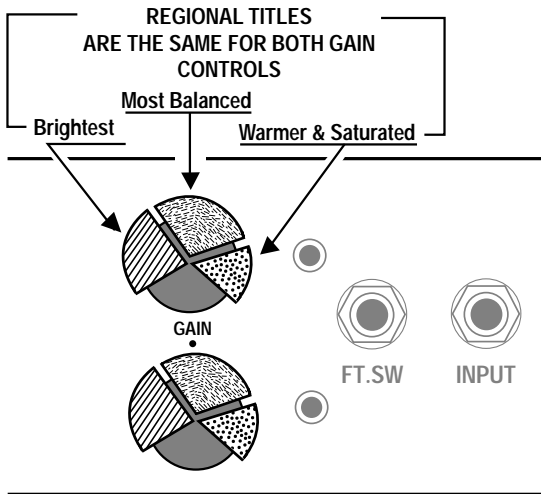

Heads, we paid special attention to the amount and frequencies of Gain present in each Mode, making sure the whole range of available Gain is musically usable. We also worked diligently with our suppliers to develop pots with tapers useful to players that require that touch sensitive relationship of input signal level to Gain saturation. An essential ingredient to a great amp's expressive nature. To maximize your expression, spend time learning the different regions of Gain in each Mode and tonal colors they enhance. Almost more - or certainly equal to the tone controls, the **GAIN** Control shapes your sound.

In most guitar amplifiers and especially in all-tube circuits, the **GAIN** Control is the most powerful control in the preamp. It shapes the overall style and character of the sound and is responsible for whether the sound is clean, overdriven or anywhere in between. In your *RECTO*, the **GAIN** Control is even more powerful. It not only determines the amount of drive, but also

acts as an integral part of the tone control string as well.

To simplify the **GAIN** Controls role in shaping the overall tone of the sound we will look at it in two ways - 1. alone and 2. in conjunction with the tone controls.

1) By itself the **GAIN** Control has basically three tonal regions -

Low (7:00 - 11:00) provides the cleanest, least saturated sounds and in this region the sound will be brighter and contain more upper harmonics lending a three dimensional character to the sound.

Middle (11:15 - 2:00) enhances the saturation and replaces some of the upper harmonics with a richer, warmer quality and a fuller bottom end response. Not yet fully saturated, this region is the easiest place to get a great sound in both channels. This region contains many of the *RECTO'S* best sounds...especially for soloing due to the crucial blend of an expressive attack combined with ample sustain.

High (2:15 - 5:00) saturates the signal and enhances low and low mid frequencies. While this region provides the maximum saturation and therefore sustain, it also compresses and softens the attack characteristics. For this reason we suggest using this higher region of the **GAIN** Control sparingly and only when maximum sustain is needed.

NOTE: Due to the *RECTO'S* extreme gain potential, the highest regions of the **GAIN** Control may possibly push the pre-amp tubes past what they can handle, producing microphonic squealing. While we screen and test the tubes your amplifier was shipped with and the tubes in your amp passed our rigorous test, we can't predict how the tubes will respond over time exposed to extreme gain settings. Your tubes are warranted for a period of 6 months under normal use, but you can save yourself the present and future inconvenience of having to deal with annoying microphonic tube problems by simply using **a little common sense...Don't turn the Gain all the way up!**

If you must for a specific part of at very low volumes, back down the **TREBLE** and **PRESENCE** Controls. Your *RECTO* was designed to provide amazing gain and tone at less than extreme settings removing the need for you to crank everything all the way up. If you are not able to achieve the sound you want at sensible setting on any or all of the controls, your problem may lie elsewhere in the signal chain, i.e. pick-ups, cabinetry, processing, etc. Keep in mind you can always call on one of our product specialists Monday through Thursday and seek some advice should you find yourself struggling to get the sound you want.

The Controls: (Continued)

2.) GAIN - In conjunction with the Tone Controls -

Basically, a simple rule applies...as the Gain is increased the Tone control string has less and less effect on the signal until at 5:00 the signal is so saturated that you are *getting mostly Gain and very little Tone*. Again, this is the reason we suggest using the **GAIN** Control in its middle region. Here the Tone control string is very active and provides maximum shaping power - allowing you to dial virtually any sound you desire.

TREBLE : As with most guitar amplifiers, the **TREBLE** Control in both channels of your **RECTO** is the most powerful of the rotary controls and is next in line only to the **GAIN** Control as a shaping tool. Because it is first in the signal path of the tone controls - and from here the **MIDDLE** and **BASS** receive their signal - it is by far the dominant tone control. For this reason the setting of the **TREBLE** Control is very important for equal representation of the three frequency regions to appear at their respective controls.

SWEET SPOT

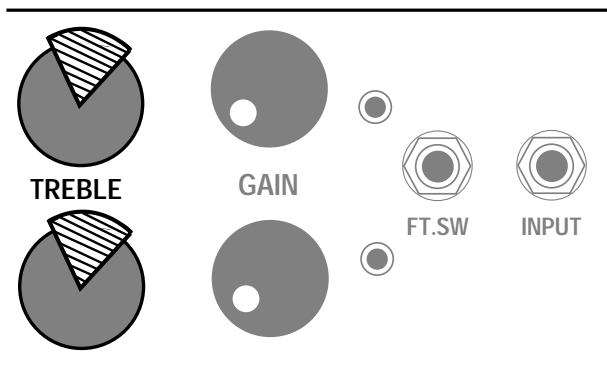

Like most of the controls on your **RECTO**, there is an optimum region of the **TREBLE** Control where ample top end is mixed in and yet enough signal is still passed on to the **MIDDLE** and **BASS** Controls.

As you might surmise, here is the sweet spot. There are definitely great sounds above and below this middle region (11:00 - 1:30), but the balance between the **TREBLE** Control and the other tone controls is compromised.

MIDDLE : The **MID** Control determines the blend of midrange punch and boldness. It also has a great deal to do with how a sound feels to play. Setting the Midrange low scoops the attack, making the sound and feel more liquid and resilient. Setting the **MID** higher introduces more punch and authority, helping sounds cut through a mix better. Setting the Mids very high may make the strings feel a little stiffer and less spongy. Keep this in mind when dialing up your sounds so that you can retain the best feel on the strings, allowing you to always play your best.

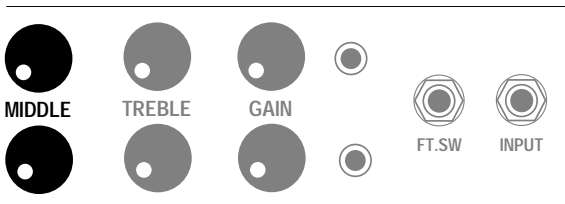

At high Gain settings in either the Vintage Orange or Modern Red Modes, the **MID** Control dials in punch and aggression. For the tightest crunch chording, set the **MID** Control high, say around 12:00 - 1:30. To make single notes feel juicier and more liquid, reduce the **MID** Control to around 7:30 or so. In the Modern Red Mode, using the **MID** higher and in

conjunction with the **PRESENCE** Control also set high, delivers a down right ugly crunch that's huge and angry - not fit for the meek! This setting also sounds great and becomes easier to play and more elastic feeling with the **GAIN** Control set at 1:00 or higher.

BASS: This control blends in the lower frequencies and its effectiveness, again, depends on the setting of the **TREBLE** Control. It should be set with moderation as extreme settings in either low or high directions can produce an unbalanced tone. Be especially

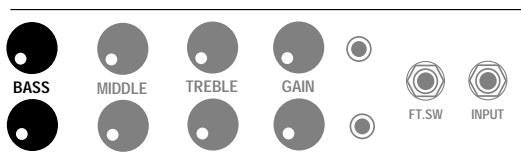

careful in higher Gain settings of either channel. Too much Bass will cause a flabby unfocused sound. Try setting the **BASS** Control around 11:00 - 2:00 for clean sounds in the Orange Channels Rhythm Mode. In the Vintage High Gain Mode and the Modern Red channel, try setting the **BASS** control somewhere between 11:00 - 2:00. These settings will vary with the amount of Gain and Treble you have dialed up.

The Controls: (Continued)

PRESENCE: These are controls that work in the power section to reduce attack and brightness. They work on a different frequency than the TREBLE Control, and depending on the Mode chosen, and the amount of Gain dialed up, can sound higher or lower than the Treble frequency. In the Clean Mode it dials in sparkle and shimmer, letting clean sounds cut through better. Balance

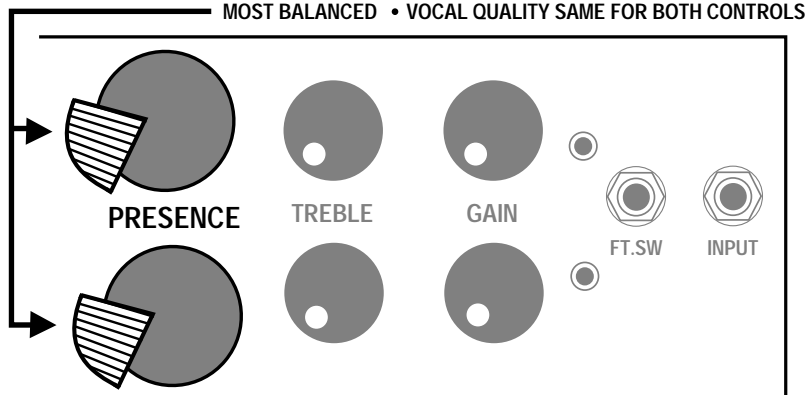

the Treble and Presence until the desired blend is reached. In distortion or high gain sounds in the Orange Channels Variable High Gain Mode, you will find it very helpful in darkening and compressing the sound for single note work.

Set the Presence low and this compression will also focus the notes and omit any unwanted buzzy frequencies. For high gain chording try higher settings of the **PRESENCE** Control to bring out the harmonic haze.

In the Red Channel the Presence circuitry is quite advanced because it switches from one type of Presence located in one part of the power section, to a different Presence circuit located earlier in the pre-amp section. This switching makes the complete transformation possible and is responsible for achieving the Modern High Gains absolute over the top status!

When the Modern High Gain Mode is called up, the Presence makes the move to a new place in the circuit and gets revoiced to work on a lower frequency. Just right for adding attack and urgency, this Presence is the aggression control. It is normal for high settings of this control to make Modern Red seem extremely loud in comparison to the other Modes. This is a result of unclamping what worked as the Presence in the other two Modes and letting the *DUAL* or *TRIPLE RECTIFIERS* ponies run free.

It is in fact, the loudest setting on the amplifier. Use this Presence with discretion as it can make for some ear damaging, almost harsh sounds if set too high. Try the Modern High Gain Mode with the GAIN Control set high, around to . Dip the MID Control to - and then increase the **PRESENCE** Control to dial in the right attack and blend of aggression. You may want to play with the balance between the MID and **PRESENCE** Controls as they are somewhat similar in that they are very powerful and dominant in Modern Red. With these two controls dialed right, Modern Red is to this day the most huge and heinous crunch we've come across. When you hear this, you will probably won't believe that this could be the same amp that moments ago was crying the blues with such mournful conviction.

Another cool use for this alternate Presence frequency shows up when you use the Vintage Orange Channels Clean Mode. Using this example: Use the CHANNEL STYLE SELECT switch on the Rear Panel and revoice the Orange Channel to Modern. You will hear your rhythm sound get louder and much punchier. This difference is largely due to the moving and revoicing of the Presence.

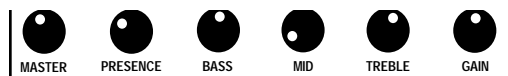

This occurs automatically when you Modernize the Orange Channel and now you instantly have a Vintage clean pre-amp with a Modern power section. This can be useful at larger gigs to boost the clean sound volume level or simply as an alternate voicing of the same Mode style.

The Controls: (Continued)

MASTER: A simple control found on most amps today, these serve to balance the playing level of the two channels. They enable the pre-amps GAIN Control to be used in a wide range of settings, while never having to affect the listening level. On both the **DUAL** and **TRIPLE RECTIFIER** Solo Heads these Masters serve another purpose as well. When the FX Loop is switched out of Bypass and programmed to either channel specifically or, simply On all the time, these MASTER Controls double as FX Loop Send Level Controls.

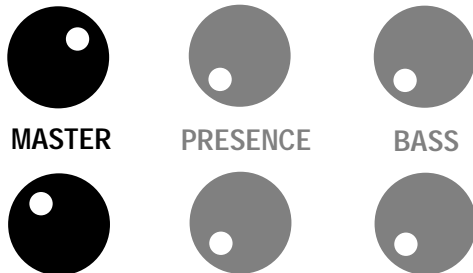

This is not their primary function, but the setting here does affect the channel's Send strength. This is not a problem because both the **DUAL** and **TRIPLE RECTIFIER'S** Solo Heads loop also incorporates a *Master Send Level* Control that compensates for the possible level mismatch when using the Masters to balance the channels. We have found the middle ranges through to be very well behaved for most effects. Setting the Masters in this region should make for trouble free FX interfacing when using the loop.

LOOP ACTIVE MASTER: This knob of a different color, works in conjunction with the FX Loop Select Rotary Control that is found on the Rear Panel in the FX Loop section of the amplifier. When the Loop is switched out of Bypass the **Yellow Loop LED** next to this control **comes on with the channel in which the loop is active. When this LED is illuminated the Loop Active Master replaces the Channel Masters to become the overall Master Volume Control. At this time the Channel Masters become channel balancing controls and Effects Loop Send Level Controls.** This **LOOP ACTIVE MASTER** Control also serves as an effects Return Control and can be very useful when trying to use certain older effects with weak output capabilities. It also makes it much easier to use the Effects Loop and makes sure that no signal is being lost to an effect's less than adequate output circuit. Let's try an experiment that will quickly show you why both the **DUAL** and **TRIPLE RECTIFIER'S** Loop is the state of the art:

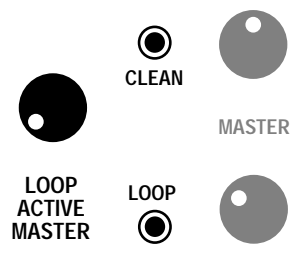

1.) Choose a sound in one of the channels and dial it in to your liking. 2.) Connect an effect processor to the FX Loop Send and Return Jacks. 3.) Set the Effect's input to preferably, but not necessarily, to Line Level. 4.) Go to the Rear Panel of either the **DUAL** or **TRIPLE RECTIFIER** Solo Head and by using the Rotary Loop Select Control, turn the Loop On all the time by setting this rotary to "**Loop on Org. & Red**". At this time the Front Panel Loop LED will come on notifying you that the **LOOP ACTIVE MASTER** now controls the Volume level of the whole amp. 5.) Increase or decrease this to about the same playing level you had before turning the loop on. 6.) Now go to the other channel and find a sound in one of the Modes.

7.) Use the Channel Master to determine its balance in relationship to the first channel you dialed up. When the listening levels are satisfactory, double check your effects processor's input headroom indicating LEDs or, if it is an old classic stomp box, listen for unwanted clipping. 8.) **Fine tune this Send Level strength with the Effects Send Level Control** in the Effects Loop section found on the Rear Panel. Use the Rotary Loop Select Control on the Rear Panel to **toggle between Loop Bypass and 'FX On Org. & Red.'** 9.) Set the FX MIX Control to the desired 'wet' blend. 10.) Adjust the volume difference between these two positions with the **LOOP ACTIVE MASTER**. If the processor you have used is a decent one, you should be able to compensate completely for any tonal thievery the unit might have caused in amps with lesser loops.

When you toggle the Loop Select in this set up, you should hear the effect come on, without noticing a disappointing difference like you would in many other effects patching scenarios. The **LOOP ACTIVE MASTER** helps greatly in avoiding this all too common occurrence. This interfacing compatibility is yet another reason why we think you will come to really appreciate this parallel FX Loop fitted to both the **DUAL** and **TRIPLE RECTIFIER** Solo Heads.

FRONT PANEL SWITCHES:

POWER / ON This switch delivers the A.C. power to these two *RECTIFIER* Solo Heads. Make sure the unit is grounded (all three terminals of the A.C. power cord must be connected whenever possible to avoid injury to the user as well as to the unit) and that the proper voltage is present. Follow the cold start procedure described in the ON / STANDBY section below when powering up either your *DUAL* or *TRIPLE RECTIFIER* Solo Head.



ON / STANDBY Perfect for set breaks... this toggle switch also serves an even more important purpose. In the Standby position the tubes are at idle so that during power up they may warm up before being put to use. Before Power is switched on make sure the STANDBY switch is in the Standby position. Wait at least 30 seconds and then flip the STANDBY to the ON position. This prevents tube problems and increases their toneful life substantially.



REST AREA

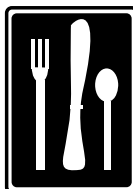
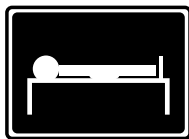

REAR PANEL:

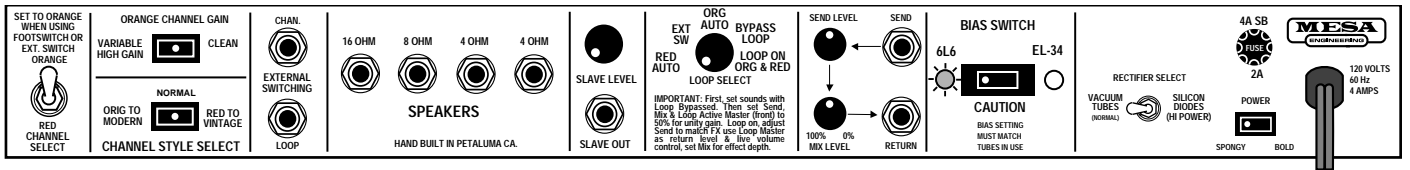

POWER: SPONGY & BOLD

The two different power selections of both the *DUAL* and *TRIPLE RECTIFIER* Solo Heads are equally important when looking for a particular sound. 'Spongy' works like a built in Variac, reducing all the internal voltages for a true vintage feeling and that extraordinary 'brown sound.' Power is reduced somewhat too, making it easier to achieve an overdriven power sound, especially when the Rectifier Select switch is in the Vacuum Tube position. Using either *RECTIFIER* Solo Head in this power setting will also extend tube life and overall reliability, while still producing enough power to work many of your gigs...and all of your recording needs! **With either the *DUAL* or *TRIPLE RECTIFIER'S* Power Select Switch in the up position, maximum power, clean headroom and volume are obtained.**

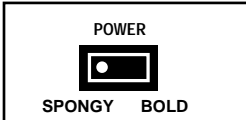

FUSE: This is the A.C.'s (Alternating Current) main fuse and provides protection from outside A.C. fluctuations as well as power tube failure damage. Should the Fuse blow, replace it with the same rating in a Slo-Blo type package. The domestic U.S. version requires a 4 amp Slo-Blo fuse. A power tube short or failure is often the cause of a blown fuse...Follow the cold start procedure mentioned in the ON/STANDBY switch section and watch the power tubes as you flip the STANDBY to the ON position. If a power tube is going bad or is arcing you will see it! Flip the STANDBY switch to Standby immediately and replace the faulty power tube and the fuse if necessary. If you see nothing abnormal as you lift the STANDBY switch, it is possible that a power tube shorted temporarily and blew the Fuse. If this is the case it may work again normally. To be extra safe, you might want to replace just the adjacent tube or all power tubes in the 'shotgun' troubleshooting tradition and save the replaced set as spares. Spare fuses are a must for the fabled cord bag along with your spare tubes. Always carry both for they could be worth their weight in gold someday.

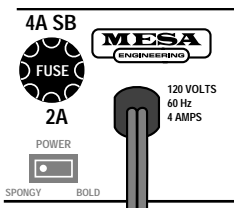

RECTIFIER SELECT:

This patented switchable feature allows you to select between two different types of rectifiers for different sounds and feel. It first appeared on our *DUAL RECTIFIER* Solo Head and is, in fact, part of the magic behind the whole Dual Rectifier series of amplifiers. It has since found its way into some of our other products as well, such as the *MAVERICK*, *HEARTBREAKER* and the *BLUE ANGEL*. Voodoo and versatility have been added to these products by the inclusion of this cool, patented feature.



SILICON DIODE: (Hi Power) calls up the silicone diode rectifiers offering more punch, a tighter attack with added brightness and substantially more headroom. This would be the preferred position for loud clean playing or tight rhythmic playing with a high front end Volume setting (high gain.)

VACUUM TUBE: (Normal) position takes a power section walk down memory lane, paying tribute to those vintage gems of yesteryear. In those early days of amplification, the only rectifiers available were tubes. Unbeknownst to their creators, these sweet sounding amplifiers would someday become relics as the demand for higher volumes and more power per package led to the abandonment of the tube rectifier in favor of the five cent silicone diode's greater efficiency. With this decision went much of the sweetness and soul, and by the mid 70's, many amps were bold, loud, and efficient, and unfortunately...sometimes lacking some of that earlier soul.

We wanted the Dual Rectifier series to capture that... 'thing' that you... 'can't quite put your finger on...but you know it when it's got it.' Soul, Personality and Feel. The Vacuum Tube position gives you a sweetness of sound and a liquid feel that simply cannot be duplicated in any other way. This position shines for single note lead work in either channel and delivers a warm, breathing clean

RECTIFIER SELECT *(Continued)*

sound in the Rhythm channel that was previously unavailable in all but the best vintage amps. If you are like most of the players we know, you'll probably end up leaving your **RECTIFIER** Solo Head, **DUAL** or **TRIPLE** set to the Vacuum Tube position all the time. Regardless of your preference the **RECTIFIER SELECT** gives you options that you won't find anywhere else and versatility that makes both of these amplifiers born vintage performer in any stylistic arena.

NOTE: On the **DUAL** Solo Head it is possible to run two 6L6 or EL34 tubes by pulling the two center tubes leaving the far left and far right tubes intact. This procedure reduces the power by approximately 50%. Remove one of the Rectifier tubes if you are using the Tube Rectifier setting to assure a correct match.

BIAS SWITCH:

Your **DUAL** or **TRIPLE RECTIFIER** Solo Head was designed with versatility in mind. So to add to the already awesome array of on board features...we felt it essential that both of these **RECTIFIER** Solo Heads be able to adapt its power output section to use the other classic pentode power tubes, the British style EL 34. These tubes are largely responsible for the signature sound of many immediately identifiable and wonderful sounding amps created in Great Britain and used on some of the best recordings to date.

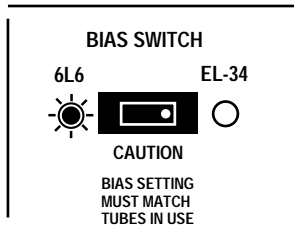

The nature of their sound is usually brighter in the extremely high frequencies...some players find this almost thin at first. However, aficionados of the EL 34 sound know that nothing has the lushness of harmonics or spread like a power amp using EL34's. In truth, EL 34's do focus in on a region of upper harmonics that 6L6's reproduce, but not really enhance in the same way the EL 34's do.

This characteristic is sometimes preferred for sounds that range from a soft clip that would be used for chording or soloing, to an all out high gain crunch or lead sound. Players that use mostly these types of sounds may prefer the EL 34 clip to the 6L6's that come standard in both the **DUAL** and **TRIPLE RECTIFIER** Solo Heads. If you need a variety of sounds and rely on a clean chording sound much of the time, you will likely prefer the stock compliment of 6L6's. We feel the 6L6 is a more balanced sounding tube that produces plenty of harmonic lushness, while at the same time delivering the rich lows that are crucial to both a warm clean sound and huge, tight high gain crunch sound.

We recommend the 6L6 for reliability: In our many tests and continued use of the currently available EL 34 type power tubes on the market today, we regret to say that they do not appear to be as rugged in construction as the available 6L6. This is another reason why your **DUAL** or **TRIPLE RECTIFIER** Solo Head was shipped with 6L6 power tubes. If you plan to use the EL 34's we suggest that you keep a full set of tubes and extra fuses with you during all performances in the event of a tube failure occurring when using the currently available EL 34's.

Make sure that the BIAS Switch is set correctly to match the tube type that you are using. Failure to do this will result in tube failure that could possibly burn resistors in the Bias supply. Although this is a fairly simple repair for an authorized technician, it is easily avoidable. ALWAYS CHECK THE BIAS SWITCH setting if you experiment with alternate tube types and you will enjoy uninterrupted performances from your amplifier of choice.

FX LOOP:

FX LOOP - SEND & RETURN:

These two 1/4" jacks are the patch point for external signal processing effects. The Effects Loop in both the **DUAL** and **TRIPLE RECTIFIER** Solo Heads is wired in parallel with the unaffected or dry signal which enables you to preserve the integrity of the all tube tone and feel that either version of this amplifier is capable of delivering. To use the Effects Loop for your processors, simply connect the Effects SEND jack to your first effects' INPUT jack. Connect your last effects' OUTPUT jack to the Effects RETURN jack.

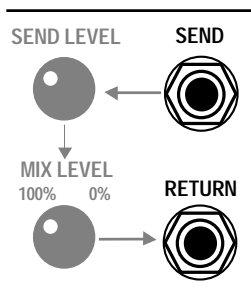

The Effects Loop interrupts the signal between the pre-amp and power section. Therefore, the Return jack can double as a 'Power Amp Input' jack. Remember that the Loop must be engaged for signal to pass this junction. You will also want to run the MIX Control at 100% to use the Loop as a Power In patch point.

REAR PANEL: (Continued)

NOTE: We suggest that when using the power section only of either the *DUAL* or *TRIPLE RECTIFIER* Solo Head, that you have the amp switched to the Vintage Orange channel and the Channel Cloning switch set to 'Normal'. This assures a more neutral power sensitivity thus making both versions more friendly to use as a power amp.

SEND LEVEL: This is the master **SEND LEVEL** Control for the parallel Effects Loop. The inclusion of this control makes it possible for different channel specific volume levels to be used via the Front Panel channel MASTER Controls, while at the same time insuring that you will not overload your processors' INPUT stage with an incompatible signal strength. For the best results, try this method:

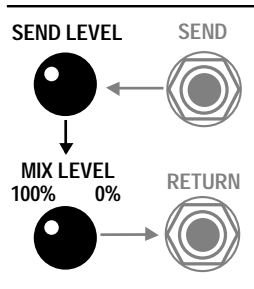

- 1.) Set up the VINTAGE and MODERN channels to your preferred Gain and Tone control settings.
- 2.) Adjust the individual channel MASTER Controls to the desired listening level.
- 3.) Set the Rear Panel Effects Loop **SEND LEVEL** Control so that your processors' INPUT indication LED is displaying the proper input signal strength (hopefully unity gain .)

4.) Adjust the Front Panel LOOP ACTIVE MASTER Control to the desired level. See page 5 on: LOOP ACTIVE MASTER - for more information regarding **SEND LEVEL**.

LOOP SELECT: This 5 position rotary type switch determines the status of the Effects Loop. The Loop can be assigned to either of the channels individually or active at all times (Loop on Org. & Red) It may also be triggered remotely with MIDI controlled switching devices by connecting the EXTERNAL SWITCHING jacks and selecting EXT. SW. on the Loop Select rotary. As you might surmise, the ORG. AUTO position assigns the Loop automatically to the VINTAGE / ORANGE Channel and every time the ORANGE Channel is called up, the Loop will be engaged. RED AUTO duplicates this scheme for the MODERN / RED Channel. For you purists, both the *DUAL* and *TRIPLE RECTIFIER* Solo Heads gives you the ability to remove all Loop circuitry from the signal path completely by selecting the BYPASS LOOP position.

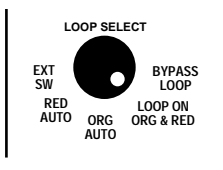

SLAVE LEVEL CONTROL: This 1/4" jack and control provide a signal derived from the speaker jack. Perfect for using either the *DUAL* or *TRIPLE RECTIFIER* Solo Head as a master pre-amp, or additional power amps may be connected for more power when needed. Some players use this to derive an FX Send Signal and go to other amps for their wet sound.

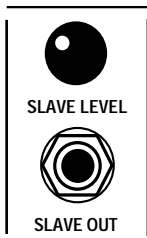

NOTE: Once a signal is taken from the Slave, it can not be inserted back into the FX Loop Return jack or a feedback loop will occur. Much like holding a microphone into the PA system's cabinets...a loud high pitched squeal will occur.

SPEAKERS: Two 4 Ohm, one 8 Ohm and one 16 Ohm jack are provided for speaker interfacing. Both *DUAL* and *TRIPLE RECTIFIER* Solo Heads are not very sensitive to speaker mismatches and will not be damaged by them, except that very low ohmage loads will cause the power tubes to wear faster. A single twelve-inch 8 Ohm speaker should generally be connected to the 8 Ohm output. When using two 8 Ohm speakers, connect them both to the 4 Ohm outputs provided (because the total load is 4 Ohms in that case.) Check out the information further back in this manual regarding speaker impedance and possible speaker hook-up schemes.

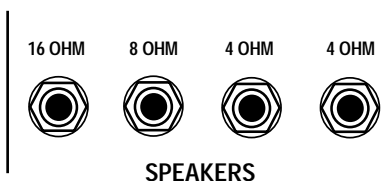

REAR PANEL: *(Continued)*

SPEAKERS: *(Continued)* 4x12 cabinets may be 4, 8 or 16 Ohms. If you are not sure of the impedance of your cabinet, you may need to remove the Rear Panel in order to verify the impedance rating of the individual speaker or speakers. **Mesa/Boogie** 4x12 and 4x10 cabinets come standard wired to 8 Ohms, and are wired in series-parallel. Some Non-**Mesa** 4x12 cabinets are wired 16 Ohms using four 16 Ohm speakers. By wiring all four speakers in parallel, you can reduce the cabinet to an impedance load of 4 Ohms (assuming the speakers are 16 Ohms each.) No matter how unusual your speaker setup, it is always possible to get good performance.

EXTERNAL SWITCHING JACKS:

These jacks allow (usually MIDI-programmed) operation of your amplifier's functions from an external switching source. In either case, the switching is accomplished by connecting ('shorting') the jack's 'Tip' to its 'Ring' (or ground.)

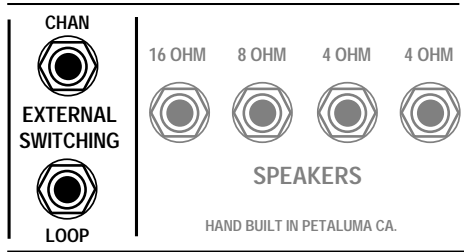

CHANNEL STYLE SELECT :

This circuit (patented) makes possible a concept, so inherently right, that in it's simplicity it was long overlooked. To be able to set a group of controls in a given channel of a two channel amplifier - to duplicate that channel and that control setting, (save for maybe one or two controls,) in another separate channel of that same amplifier. Sound simple? Well it would be, but most, if not all amplifiers, must use the available internal space to offer circuitry and Front Panel real estate for alternate channels that vary greatly in both gain structure and tonality. CHANNEL STYLE SELECT is our answer to this channel expanding idea. By providing two identical groups of Front Panel controls and interfacing each of them to it's own different and dedicated channel, we achieve the Vintage Orange and Modern Red channels. Sophisticated internal switching circuitry then enables you, the user, to utilize the channels for their differences - 'Normal' or; with a flick of the switch - Clone them 'Orange to Modern' or 'Red to Vintage.' This allows for virtually any combination of

your two favorite sounds to be footswitchably possible even if they are normally found in the same channel! CHANNEL STYLE SELECT greatly enhances the versatility of both the **DUAL** and **TRIPLE RECTIFIER** Solo Heads live or in the studio, while retaining its clean Front Panel layout.

NOTE: When the **CHANNEL STYLE SELECT** feature is used and the Modern Red channel is cloning Red to Vintage (so that it sounds like the Orange channel) - be aware that both the Orange and Red channels' **PRESENCE** Controls are active in the (bottom) Red channel in this setting only. Some amazing sounds are possible because the two **PRESENCE** Controls maintain their respective voicing differences giving you two regions of top end harmonics to play with in this Mode.

CHANNEL SELECT :

This switch simply allows you to switch between the two channels (Vintage/Orange and Modern Red) without using the Channel Select Footswitch or, when one is not available. **To use the footswitch however, the Channel Select switch must be in the up (ORANGE) position.**

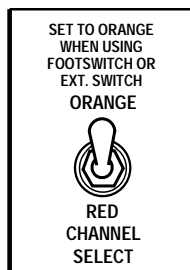

FACTORY SAMPLE SETTINGS

SAMPLE 1

Clean

Orange Channel Gain:

— Clean Rhythm





LOOP ACTIVE MASTER



 MASTER



 PRESENCE



 BASS

 MID

 TREBLE

 GAIN

 FT.SW



 INPUT

SAMPLE 2

Purring Blues

Orange Channel Gain:

— Variable High Gain





LOOP ACTIVE MASTER



 MASTER



 PRESENCE



 BASS

 MID

 TREBLE

 GAIN

 FT.SW

 INPUT

Orange Channel Gain - Variable High

SAMPLE 3

Liquid Metal / Tight Mosh

Power Section:

— Spongy or Bold
— Tube Rectifier.





LOOP ACTIVE MASTER



 MASTER



 PRESENCE



 BASS

 MID

 TREBLE

 GAIN

 FT.SW

 INPUT

Orange Channel Gain - Variable High

SAMPLE 4

Orange Crunch / Molten Red

Power Section:

— Bold
— Solid State Rectifier





LOOP ACTIVE MASTER



 MASTER



 PRESENCE



 BASS

 MID

 TREBLE

 GAIN

 FT.SW



 INPUT

PAGE 12

PERSONAL SAMPLE SETTINGS

SAMPLE 1

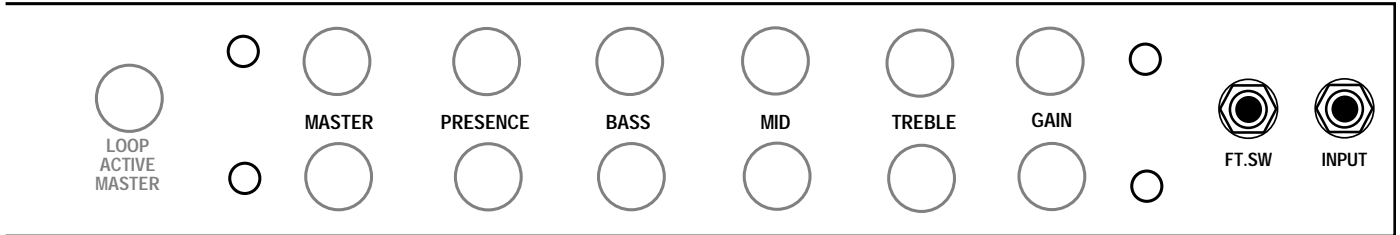
Power Section:



Control panel for Sample 1. It features a 'LOOP ACTIVE MASTER' knob on the left, followed by two rows of knobs for 'MASTER', 'PRESENCE', 'BASS', 'MID', 'TREBLE', and 'GAIN'. To the right of these are two small circular buttons. On the far right are two footswitches labeled 'FT.SW' and 'INPUT'.

SAMPLE 2

Power Section:

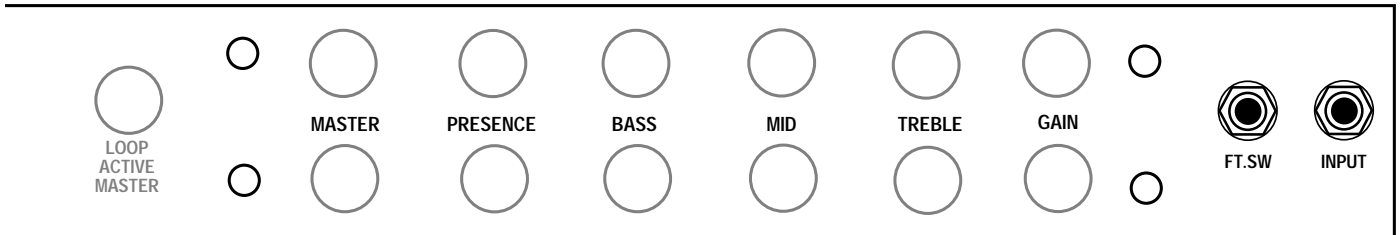

Control panel for Sample 2. It features a 'LOOP ACTIVE MASTER' knob on the left, followed by two rows of knobs for 'MASTER', 'PRESENCE', 'BASS', 'MID', 'TREBLE', and 'GAIN'. To the right of these are two small circular buttons. On the far right are two footswitches labeled 'FT.SW' and 'INPUT'.

SAMPLE 3

Power Section:

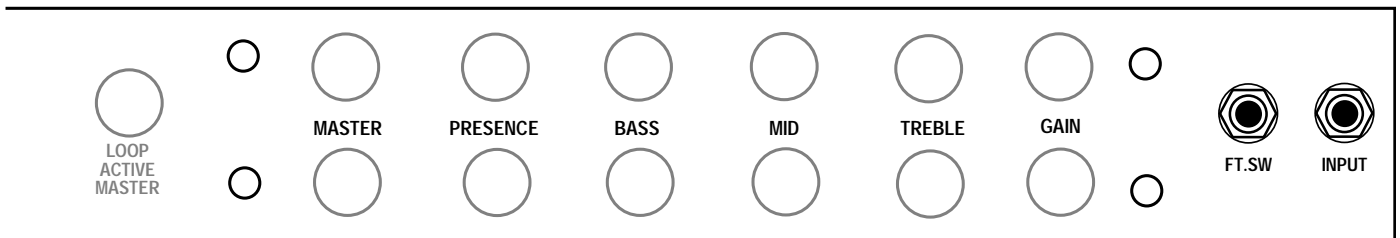

Control panel for Sample 3. It features a 'LOOP ACTIVE MASTER' knob on the left, followed by two rows of knobs for 'MASTER', 'PRESENCE', 'BASS', 'MID', 'TREBLE', and 'GAIN'. To the right of these are two small circular buttons. On the far right are two footswitches labeled 'FT.SW' and 'INPUT'.

SAMPLE 4

Power Section:

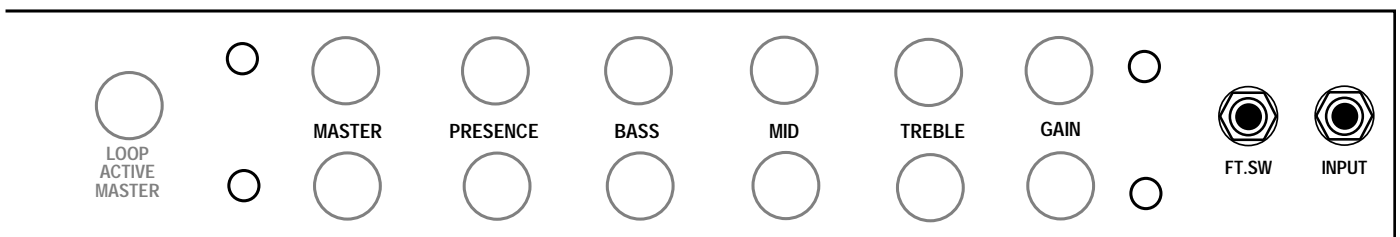

Control panel for Sample 4. It features a 'LOOP ACTIVE MASTER' knob on the left, followed by two rows of knobs for 'MASTER', 'PRESENCE', 'BASS', 'MID', 'TREBLE', and 'GAIN'. To the right of these are two small circular buttons. On the far right are two footswitches labeled 'FT.SW' and 'INPUT'.

DUAL RECTIFIER

Solo Head TUBE TASK CHART

BACK EDGE OF CHASSIS

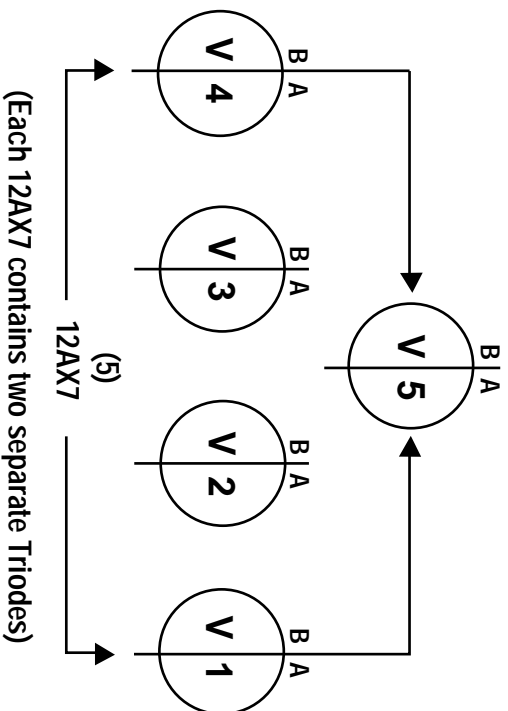
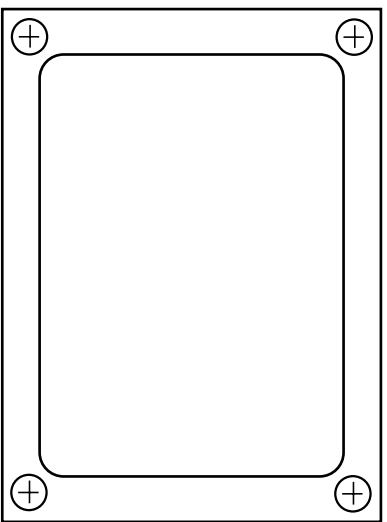
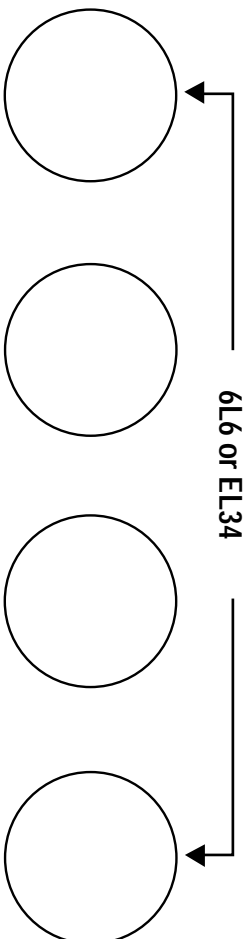
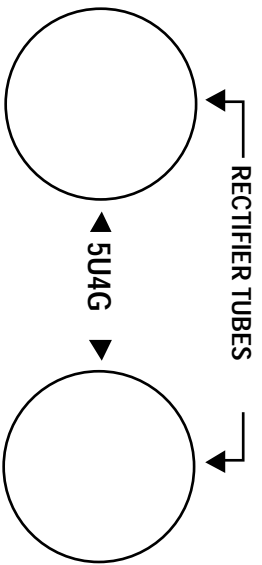

PARTIAL VIEW OF CHASSIS

Description of Tube Functions

V1 A = Input Stage
 V1 B Not Used
 V2 A = 2nd Stage
 V2 B = 3rd Stage
 V3 A = 4th Stage

V3 B = 5th Stage
 V4 A = FX Send
 V4 B = FX Return
 V5 A = Phase Splitter /
 V5 B = Output

TRIPLE RECTIFIER

Solo Head TUBE TASK CHART

BACK EDGE OF CHASSIS

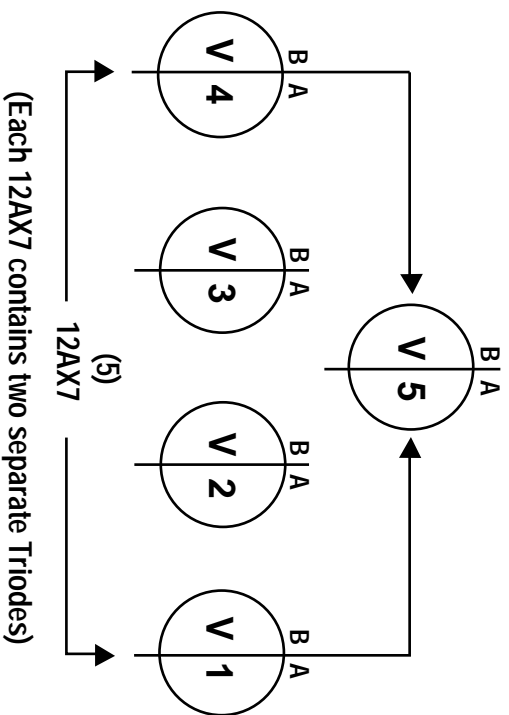
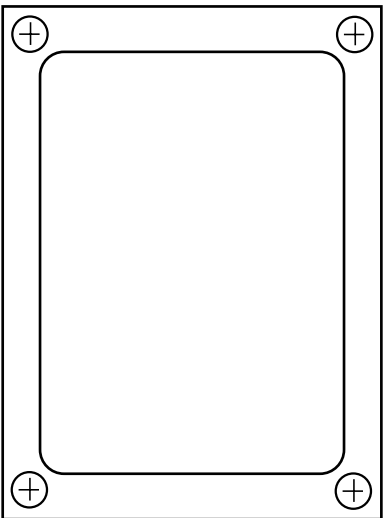
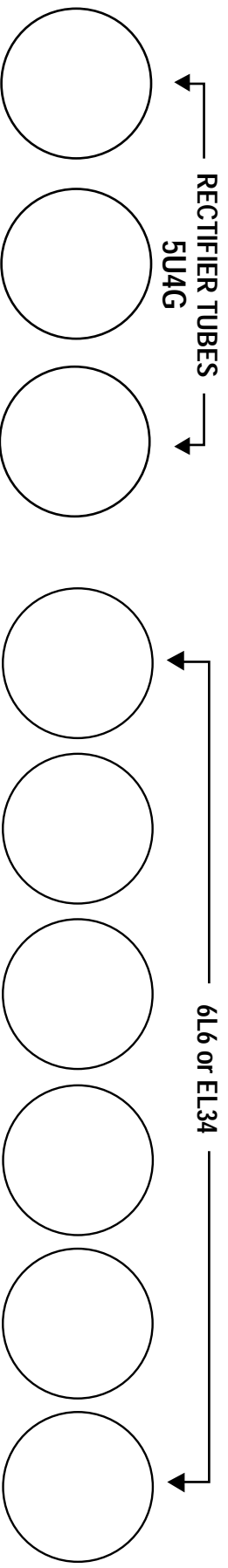

PARTIAL VIEW OF CHASSIS

Description of Tube Functions

- V1 A= Input Stage
- V1 B Not Used
- V2 A= 2nd Stage
- V2 B= 3rd Stage
- V3 A= 4th Stage

- V3 B= 5th Stage
- V4 A= FX Send
- V4 B= FX Return
- V5 A= Phase Splitter /
- V5 B= Output

TUBE NOISE & MICROPHONICS

You may occasionally experience some form of tube noise or microphonics. Certainly no cause for alarm, this quirky behavior comes with the territory and the Tone. Much like changing a light bulb, you don't need a technician to cure these types of minor user serviceable annoyances and in fact, you'll be amazed at how easy it is to cure tube problems...by simply swapping out a pre-amp or power tube!

First may we suggest that you set the amplifier up on something so that you can get to the tubes comfortably without having to bend down. It also helps to have adequate lighting as you will need to see the tube sockets clearly to swap tubes. Use caution and common sense when touching the tubes after the amplifier has been on as they may be extremely hot! If they are hot and you don't want to wait for them to cool off, try grasping them with a rag and also note that the glass down around the bulbous silvery tip is considerably less hot which makes it easier to handle. Gently rock the tube back and forth as you pull it away from its socket.

DIAGNOSING POWER TUBE FAILURES:

There are two main types of tube faults: shorts and noise. Both large and small tubes may fall prey to either of these problems but diagnosis and remedy is usually simple.

If a fuse blows, the problem is most likely a shorted power tube and shorts can either be mild or severe. In a mildly shorted tube the electron flow has overcome the control grid and excess current flows to the plate. You will usually hear the amp become distorted and begin to hum slightly. If this occurs, quickly look at the power tubes as you switch the amp to STANDBY and try to identify one as glowing red hot. It is likely that two of a pair will be glowing since the "shorted" tube will pull down the bias for its adjacent mates, but one tube may be glowing hotter — and that one is the culprit. The other two are often fine — unless they've been glowing bright red for several minutes.

Because there is no physical short inside the tube (just electrons rioting out of control) merely switching to STANDBY for a few moments then back to ON will usually cure the problem...at least temporarily. Watch the tubes carefully now. Should the problem recur, the intermittent tube will visibly start to over heat before the others and thus it can be identified. It should be replaced with one from the same color batch, shown on its label. Call us and we will send one out to you.

The severe short is not nearly so benign. In the worst cases, a major arcing short occurs between the plate and the cathode with visible lightning inside the glass and a major noise through the speaker. If this is seen to happen, IMMEDIATELY turn the amp to STANDBY. By this time the fuse probably will have blown. Such a short is usually caused by a physical breakdown inside the tube including contaminate coming loose or physical contact (or near contact) between the elements. Replace it and the fuse with the proper slo-blo type and power up the amp using the power up procedure as we described earlier in this manual.

TUBE NOISE:

Often caused by contamination within in a tube, the culprit can usually be identified, and by lightly tapping on the glass, you will probably hear the noise change. Hearing some noise through the speakers while tapping on the 12AX7's is normal however. And the one nearer the INPUT will always sound louder because its output is being further amplified by the second 12AX7.

The power tubes should be all but quiet when they are tapped. If crackling or hissing changes with the tapping, you have probably found the problem. To confirm a noisy power tube, merely put the **RECTO** on Standby, remove it from its socket and turn it back on. It will cause no damage to run the **RECTO** briefly with one power tube missing. You may notice a slight background hum, however, as the push-pull becomes unbalanced. Whenever you are trying to diagnose a suspect tube, keep your other hand on the POWER and STANDBY switches ready to shut them off instantly in the unlikely case you provoke a major short.

If you think you've located a problem tube but aren't sure, we recommend substituting the suspect with a new one just to be sure of your diagnoses. You will be doing yourself and us a big favor by just following the simple guidelines previously mentioned regarding tube replacement. You'll probably be successful with much less effort than is required to disconnect everything and haul the unit to a technician who will basically perform the same simple tests. If the tubes are still within their six-month warranty period, we will happily send you a replacement. Just note the color designation on the tube label so that we can send you the appropriate match.

DIAGNOSING PRE-AMP TUBE PROBLEMS:

Because your amplifier is an all tube design, it is quite possible that you will at some point experience minor pre-amp tube noise. Rest assured - this is no cause for alarm and you can take care of the problem yourself in a matter of minutes by simply swapping tubes.

Let us begin by saying; It is a "very good" idea to keep at least a couple of spare pre-amp tubes on hand at all times to insure uninterrupted performance. These minor pre-amp tube problems can take many forms but can generally be described in two categories: Noise and Microphonics. Noise can be in the form of crackling, sputtering, white noise/hiss and/or hum. Microphonic problems usually appear in the form of a ringing or high pitched squealing that gets worse as the gain or volume is increased thus are more noticeable in the higher gain "HI" modes. Microphonic problems are easily identified because the problem is still present even with the instruments' volume off or unplugged altogether - unlike pick-up feedback which ceases as the instrument is turned down. Microphonic noise is caused by mechanical vibration and shock: think of banging a microphone around and you'll understand where the word came from.

The best way to approach a pre-amp tube problem is to see if it occurs only in one specific mode or channel. This should lead you to the tube needing replacement. Then all that remains is to swap the suspect tube for a known good performer.

If you cannot narrow down the trouble to a specific mode or channel, the problem may be the small tube that drives the power tubes which is operational in all modes and channels. Though rare, a problem with the driver tube would show up in all aspects of performance - so if you can't narrow the problem down to being mode or channel specific, you may want to try replacing the driver tube. Driver problems generally show themselves in the form of crackling or hum in all modes of performance and/or weak overall output from the amplifier. Occasionally an anemic driver tube will cause the amplifier to sound flat and lifeless, but this is somewhat uncommon, as worn power tubes are a more likely suspect for this type of problem.

Sometimes making the diagnosis is more trouble than it's worth and it's faster and easier to merely replace the small pre-amp tubes ONE AT A TIME with a replacement known to be good. But MAKE SURE you keep returning the tubes to their original socket until you hit the one that cures the problem. You'll notice that tubes located nearer to the INPUT jack always sound noisier...but this is because they are at the start of the chain and their noise gets amplified over and over by the tubes that follow. The tube that goes into this "input socket" (usually labeled V1) needs to be the least noisy of the bunch. The tube that goes at the end of the preamp chain - just ahead of the power tubes - can be quite noisy without causing any problem at all. The tubes in your amp have already been located in the most appropriate sockets and this is why you should NEVER pull them all out at once and ALWAYS swap them one at a time. ALWAYS return a perfectly good tube to its original socket. Also it's a good idea to put the amp on STANDBY when swapping tubes to reduce the heat build up in the tubes themselves and to prevent explosive noises (which can still occur even if you are pulling the tubes away from their sockets gently) from coming through the speaker.

Remember, take your time, be patient and chances are real good that you can fix your amp yourself by finding and replacing the bad tube. It kills us to see someone who has shipped their amp back to us...and all it needed was a simple tube replacement! If you must send back your amp, unplug the power cord, speaker and reverb cables then remove the chassis from the cabinet by unscrewing the four mounting bolts on top. The chassis then slides back like a drawer and comes out. Remove the big power tubes and mark them according to their location from left to right 1, 2 etc. They need to be wrapped separately with plenty of wadded up newspaper around them and put in a smaller box within the larger carton.

To wrap the chassis, use plenty of tightly wadded up newspaper so there is at least six inches of "crush space" between the chassis and the cardboard box. Bubble wrap also works well, but please DON'T use styrene peanuts - they will shift during transit and get lodged inside your electronics as well as allowing your amp to end up at the bottom of the box unprotected and possibly damaged. Pre-amp tubes don't normally wear out as a rule.

Therefore, it is not a good idea to change them just for the sake of changing them. If there isn't a problem - don't fix it. If there is no result from your substitutions, it may be possible that you have more than one problematic tube. Though rare, this does happen and though it makes the troubleshooting process a little more intimidating, it is still possible to cure the problem yourself.

NOTE: It is normal to hear a slight metallic ringing sound when tapping on the preamp tubes. As long as the tube does not break into oscillation or start crackling or any other form of bizarre noise, it is considered normal and functional.

BIAS ADJUSTMENT: *(Part of a continuous series)*

An Article written by Randall Smith that we thought you might find interesting.

Here's a question we often hear:

"Why doesn't **MESA** put bias adjustments in their amplifiers?"

Well, there's a short answer and a long answer to this question.

The short answer is that during my 12 years of repairing Fenders, one of the most frequent problems I saw was bias controls that were either set wrong or that had wandered out of adjustment due to vibration. As any honest tech will tell you, there's lot's of easy money to be made by sprinkling "holy water" on amplifiers ... uh, what I meant to say is "Your amp needed biasing." See what I mean? What customer is going to argue with that?

It only takes a moment and a volt meter: The Fender diagram shows how: "Adjust this trim pot for - 52 volts." That's it. Nothing more.

Now don't be fooled into thinking that tubes "draw" more or less bias, they don't. The way a bias supply is connected to a tube is akin to a dead end road, it just trails off to nowhere without really completing a circuit. It's a static voltage and regardless of what tube is in the socket — or even if the tubes aren't plugged in at all, it doesn't change the bias voltage a bit.

So the end of the short answer is this: Since a bias supply needs to put out the right voltage and never vary, I wanted to build amplifiers that were individually hard wired to the correct values and NEVER needed adjustment. And for 25 years, that's how **MESA/Boogies** have been built.

Time to change tubes? Just plug our tubes into any one of our amps and you're DONE. No tech needed. NO bills and no BS about biasing. And most important: The bias is RIGHT because it can't change!

Now, you want the long answer? Here's more information on how our hard-wired bias avoids trouble. Please read on.

But first, let's make an important distinction. Our business is designing and building high performance amplifiers. And for this we need tubes whose variance is within a narrow range. Our warehouse is full of rejects ...oh, they work — they just don't perform within our tolerance range. We have a very sophisticated computer - based tube testing system (nicknamed "Robotube") that matches and measures tubes over seven important parameters. It can even predict which tubes are likely to have a shortened lifetime — even though they work perfectly during the test.

Because our business is building quality amps, we can afford to reject a lot of wayward tubes. The guys you hear complaining because **Boogies** don't have bias adjusters are primarily in the business of selling tubes - not amps. They don't want to throw away 30 percent of their inventory, so they promote the idea that tubes outside our parameters can be used to "customize" amplifiers and they criticize us because our amps can't be adjusted to accommodate their out-of-**MESA** tolerance tubes.

Now you might be thinking, "But I thought you just said that tubes don't "draw" bias, therefore they don't effect the bias supply and thus it doesn't need to be adjustable."

When you set the bias (whether it's by selecting the right resistors, as we do, or adjusting a trimmer — which is quicker) what you are doing is establishing the correct amount of idle CURRENT that flows through the power tubes. But you can't adjust the current directly, you can only change it by adjusting the amount of bias VOLTAGE that goes onto the tubes' control grids.

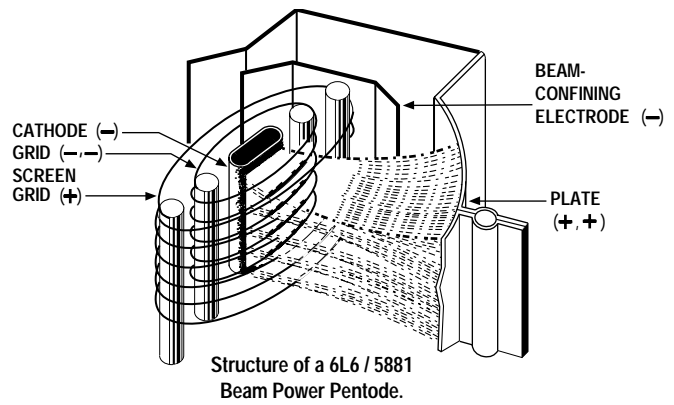

BIAS ADJUSTMENT *(Continued)*

Voltage and current are NOT the same. Current is the AMOUNT of electricity, the “quantity” — and is measured in amperes. Voltage is the degree of electric charge — like the “pressure” to use the old water analogy. Let me illustrate how different voltage and current are:

When you scrape your feet across a carpeted floor in dry, wintery conditions, your body can become charged with 50,000 to 100,000 volts of static electricity. And when you reach for the door knob, a spark jumps and you feel it! The voltage is super high but the current (measured in micro-amps) is tiny - otherwise you would die from electrocution.

Contrast this with your car battery, which puts out a mere 12 volts. You can lay your hands right across the terminals and not feel a thing. Yet the amount of current available can run to several hundred amperes .. enough to turn over a cold engine and get it started.

So current and voltage are two totally separate electrical parameters — though when you multiply them together, you get POWER, which is measured in watts.

When you set the bias of an amplifier, you are adjusting the static VOLTAGE at the control grid of the tube in order to produce a desired amount of idle CURRENT flowing to the tube’s plate. A small change in grid voltage, produces a large change in the amount of current flowing — and that’s basically how a tube works. Say that again because it’s super important: A small change in voltage at the grid causes a large change in current flowing to the plate. See, that’s the essence of amplification: A small change causing a large change. And here it’s a small voltage change causing a large current change.

The bias conditions are what determines how much current flows through the big power tubes when you’re not playing. And what drives your speakers is fluctuations in that current flow when ARE playing. If the amount of current increases and decreases 440 times per second, then you’ll hear an A note. If the fluctuations in current flow are large and still at 440 per second, you’ll hear an A that is LOUD!

But for purposes of biasing, it’s the amount of “plate current” flowing with no signal applied that’s important. Unfortunately current is hard to measure because the circuit must be interrupted — as in “cut the wire” — and the meter spliced “in series” with the broken circuit. But measuring VOLTAGE is easy. It is not necessary to interrupt the circuit because a voltage reading can be taken in PARALLEL with the circuit intact.

Thus, as a matter of convenience, most bias settings are given in volts at the grid ... even though current through the plate is the important factor. In fact plate current is so inconvenient (and dangerous) to measure that Fender doesn’t even state what the correct value should be. They only give the grid voltage that will produce that current. (That’s the minus 52.) But that only happens if the tubes being used are “in spec.”

As long as the tubes ARE “in spec”, the right bias voltage will always give the correct plate “CURRENT” — but then there’s no need for the bias voltage to be adjustable!

If the tubes are NOT in spec, then the only proper way to re-set the bias is to cut the circuit and measure the current while adjusting the bias ... but no manufacturer I know even STATES the desired current value! Be that as it may, when the original bias voltage is altered far enough, it will compensate for the tube’s abnormal performance and the correct amount of idle current flow may then be restored. Clearly this is something most repair techs should not attempt.

Some newer amps have LED indicators connected to the circuit which will turn on when the right threshold of current flow has been reached. This is an improvement, and almost worthy if you’re willing to except resistors and lights added into your amplifier’s audio path — which we aren’t.

The other “advantage” of this system is that it allows some amp manufacturers to avoid matching their power tubes. The thinking is that adjusting the bias to each tube separately eradicates the inherent differences between the tubes by insuring that the same current flows through each one.

Again, this has some merit .. but it’s still not as good as using tubes that are matched in the first place because compensating for the

BIAS ADJUSTMENT *(Continued)*

mis-match causes the push-pull circuit itself to become unbalanced. Two wrongs don't really make a right.

Some of the other recommended biasing, "methods" — such as -".. tubes running red hot, increase the bias .. sounds harsh and runs too cool, turn it down ..." are guesswork at best. Luckily, one of the great things about tube amps is that they can usually stand some abuse without causing any real harm ... at least not immediately. But don't these alterations imply that you are second-guessing the amp designer and that there's a better set of operating conditions that the designer missed but the tube sellers have discovered?

Now some players may like the sound of their amp altered by tubes with extreme characteristics and with the bias set to help compensate. But often it is the mere novelty of change that they're really responding to and when the amp goes back to the proper original way, we've seen them be far happier still!

Because every part in every one of our designs has been meticulously evaluated, compared and stressed over — no matter how seemingly insignificant it might be. And with every design we look for a "sweet spot" where all the parameters — including the bias — come together to give the best sonic performance, consistently and reliably. Every part and voltage is important — yet no one complains that these other parameters aren't available for tinkering.

Consider our patented **Simul-Class** circuitry where there are two different bias voltages used for separate pairs of power tubes ... and changing one voltage also changes the other. Great care goes into getting this just right and we think we'd be asking for trouble to have it adjustable for the world to play with ... unless you like paying to have your amp messed up. Sorry, I meant to say, "Uh, ... your amp needed biasing."

If that doesn't appeal to you, then merely plug a matched set of **MESA** tubes into one of our amps and you're ready for tone. Guaranteed. You'd be amazed at the number of service calls we field every day that lead to a diagnosis of out-of-tolerance, non-spec tube problems. To think these would be prevented by including a bias adjustment is something of an insult to you and us. If you put the wrong size tires on your car, do you think changing the pressure will make them right?

Please, don't think this is a blanket indictment of the other guys selling tubes — it isn't. And their tubes aren't all bad either. It just doesn't make sense to pay more of your hard earned cash for tubes that were probably made in the same Russian or Chinese factory and which have the possibility of being outside the performance window we select for your amp. And it pains us to hear the hype and mystique built up around biasing when twenty-five years of evidence affirms our decision to make bias circuits that "never need adjustment". How much money and trouble that has saved **MESA/Boogie** players you couldn't estimate.

Our rigorously tested and hand selected tubes are available at your nearest **MESA/Boogie** Pro Center or from us directly. Nobody offers better price, quality or warranty than we do ... so why swerve?

Next time we'll talk about our part in developing the great Sylvania STR 415 type 6L6 and how we're on the verge of seeing something fairly close reappear on the market. Remember, we still have some of these super rugged mondo-bottles available for older amps — **Boogies** only please! Until then, Relax, Breathe and Nourish your soul!

Cheers!

MESA/Boogie Ltd.

Randall Smith
Designer & President

SPEAKER IMPEDANCE MATCHING & HOOK-UP GUIDE:

IMPEDANCE: Wiring up speakers to provide the most effective load and making sure that all of them are in phase will help in creating the best sound possible. This is not too difficult, as long as you understand a few things about loading and how to connect your speakers to provide an optimal resistive load.

MESA/Boogie amplifiers can handle 4 and 8 ohms effectively. Never run below 4 ohms in a tube amplifier unless you are absolutely certain that the system can handle it properly; this can cause damage to the Output transformer. A few amplifiers can handle 2 ohms effectively without damaging them (for example the **MESA's Bass 400+**). You can always have a higher resistance (16 ohms, for example) without damaging results, but too low of a resistance will likely cause problems.

MIS-MATCHING: When running a higher resistance (for example: 8 ohm output into 16 ohm cabinet), a slightly different feel and response will be eminent. A slight mismatch can provide a darker smoother tone with a little less output and attack. This response is a result of the amplifier running a bit cooler. Sometimes when using more than one cabinet a mismatch will be the only option.

WHAT IS MY CABINETS IMPEDANCE: If you have only a single speaker, you just match that single speakers impedance to the amplifier, and you are done. In many cases, you will have a number of speakers, and then you must calculate the "load" that the amplifier will need to support. There are generally three ways to wire multiple speakers together. They are as follows:

SERIES: When you wire (hook-up) speakers in Series, the speakers resistance (as measured in ohms) is additive - i.e. putting two 8 ohm speakers in Series results in a 16 ohm load.

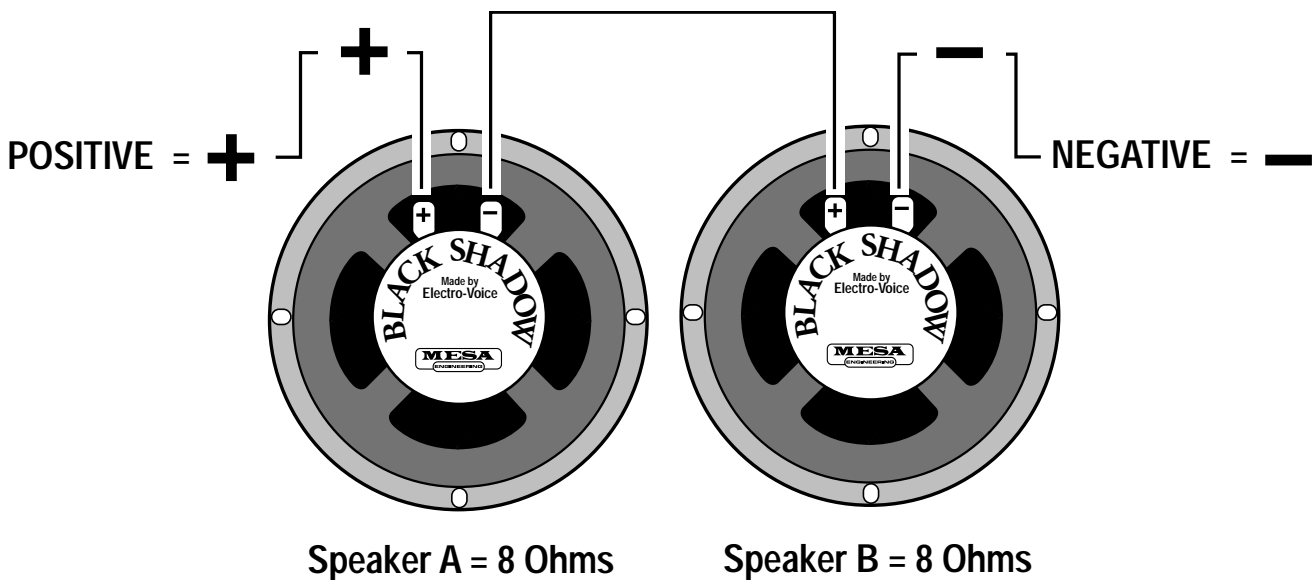

SERIES: Connect the Negative side of Speaker A to the Positive side of Speaker B

SPEAKER IMPEDANCE MATCHING & HOOK-UP GUIDE: (Continued)

PARALLEL: When wiring in parallel, the resistance of the speakers decreases. Two 8 ohm speakers wired in (hooked-up) Parallel results in a 4 ohm load. It's easy to calculate the effect of a resistive load when all the speakers are all the same resistance. It is really not suggested to wire different resistive load values in Parallel (8 and 4, 16 and 8 etc.) The formula for figuring the total impedance in Parallel is the multiplication of the two loads divided by the sum of the two loads - i.e. putting two 8 ohm speakers in Parallel results in a 4 ohm load. Connect the Positive side of Speaker A to the Positive side of Speaker B - Connect the Negative side of Speaker A to the Negative side of Speaker B.

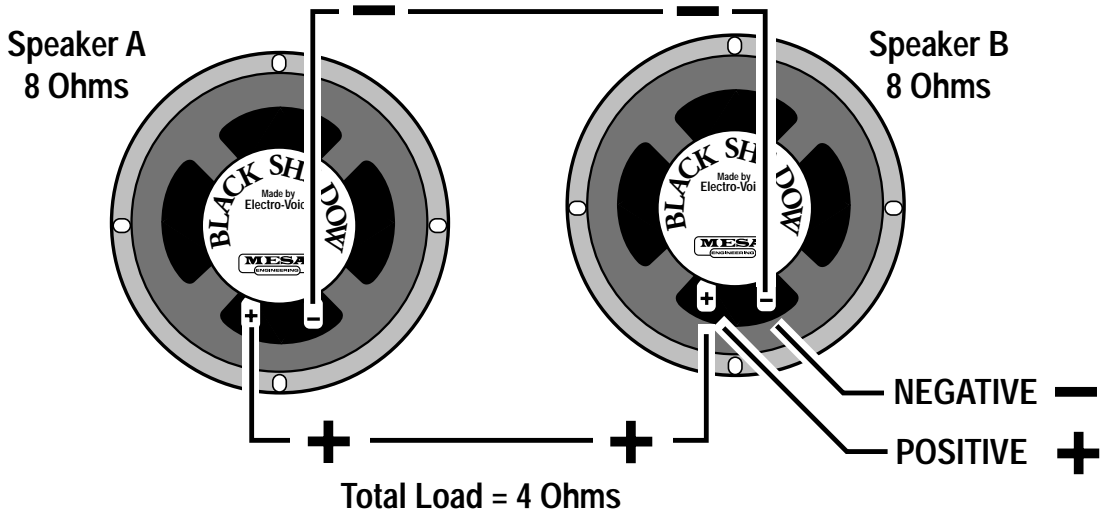

COMBINATION OF SERIES & PARALLEL: This is really just two sets of Parallel wired speakers connected in series. This is how you maintain a consistent load with multiple speakers. The importance of this is more evident when you have more than one cabinet to connect to your amplifier. This is when you need to figure out the loads and how to wire them up without applying too low of a resistance on the amplifier.

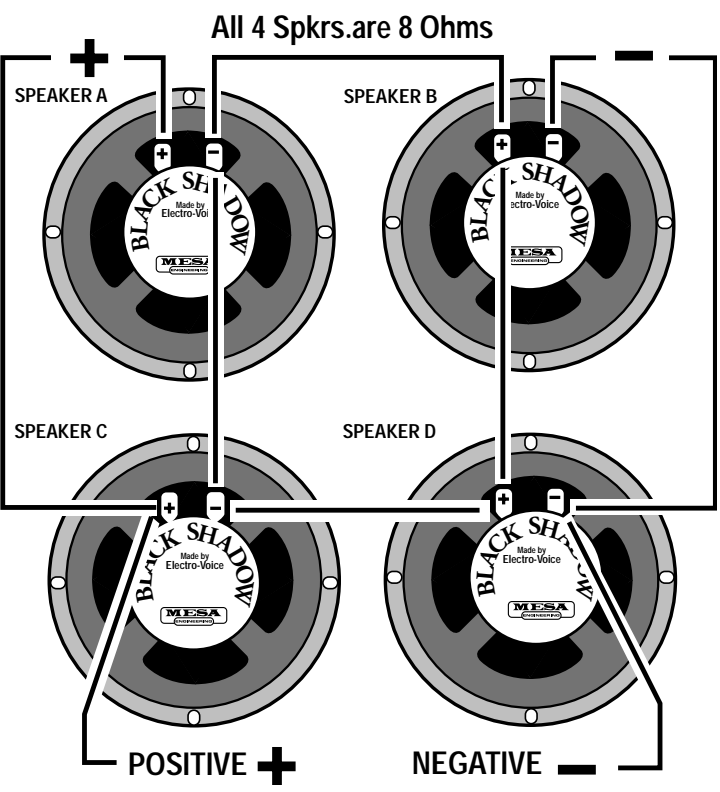

Simply connect the Positive side of Speaker A to the Positive side of Speaker C.

Connect the Negative side of Speaker A to the Positive side of Speaker B, then on to the Positive side of Speaker D and finally on to the Negative side of Speaker C.

And lastly, connect the Negative side of Speaker B to the Negative side of Speaker D.

4 Eight (8) Ohm speakers wired in Series Parallel = a Total Load of 8 Ohms.

1

WIRING SCHEMES...Amplifier to Speaker Cabinets

2

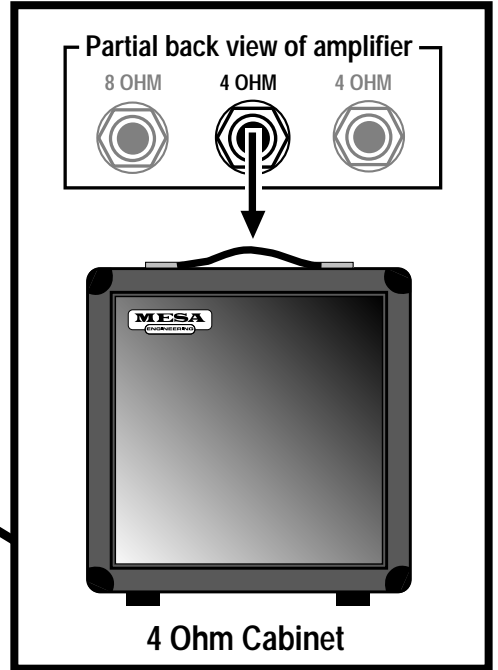
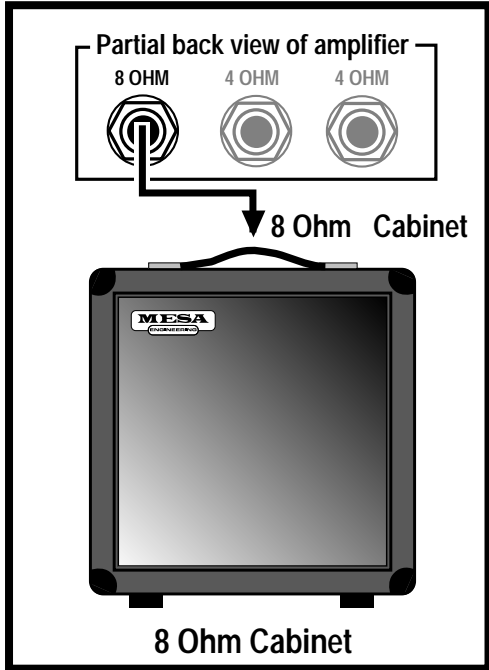

3

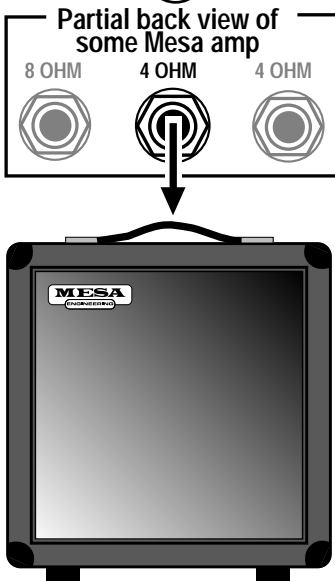

4

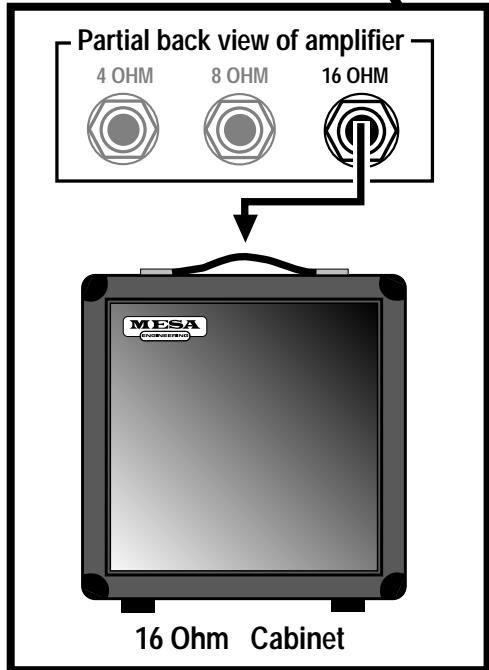

5

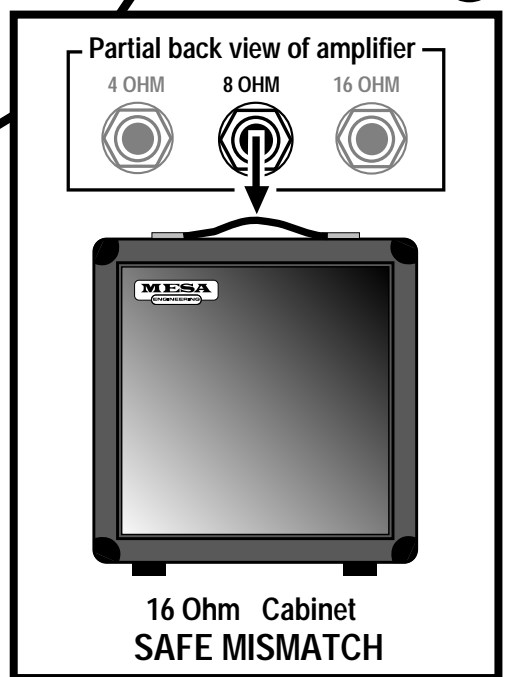

WIRING SCHEMES...Amplifier to Speaker Cabinets

6

7

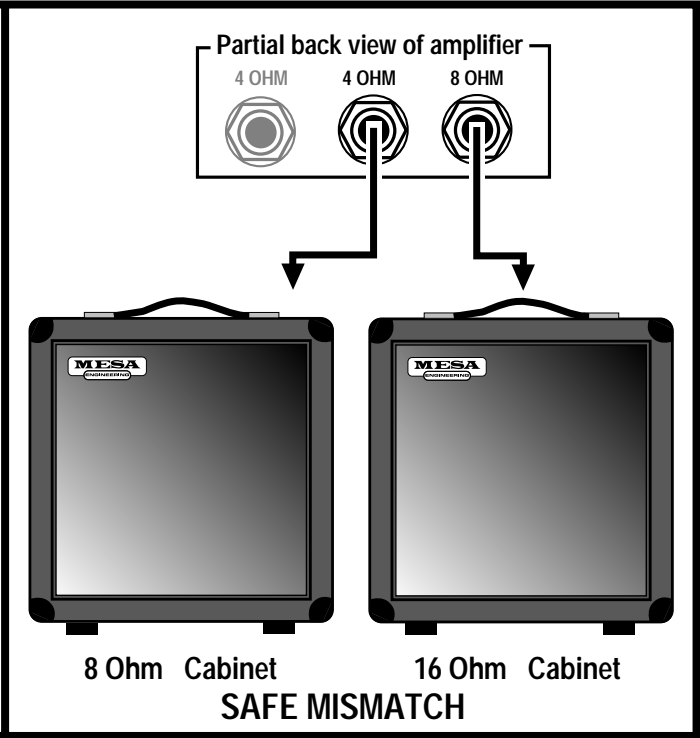
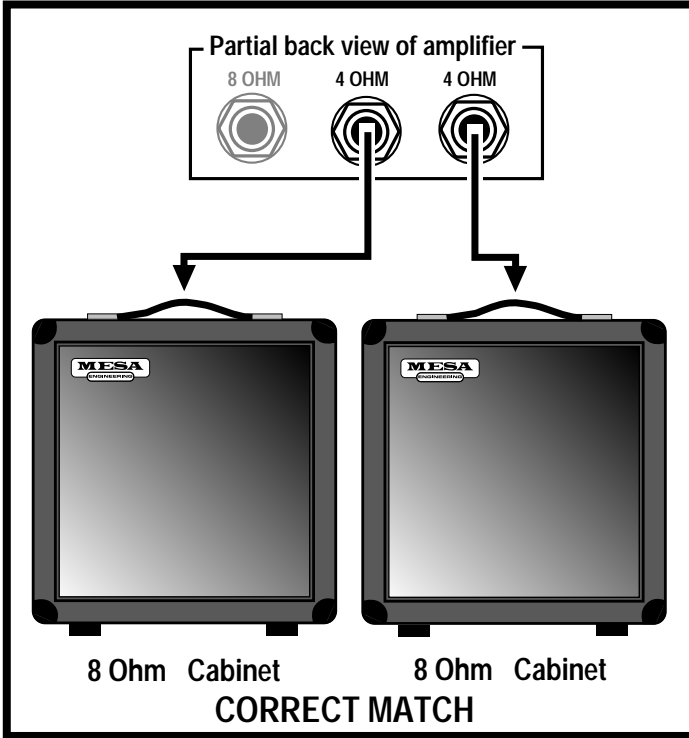

8

9

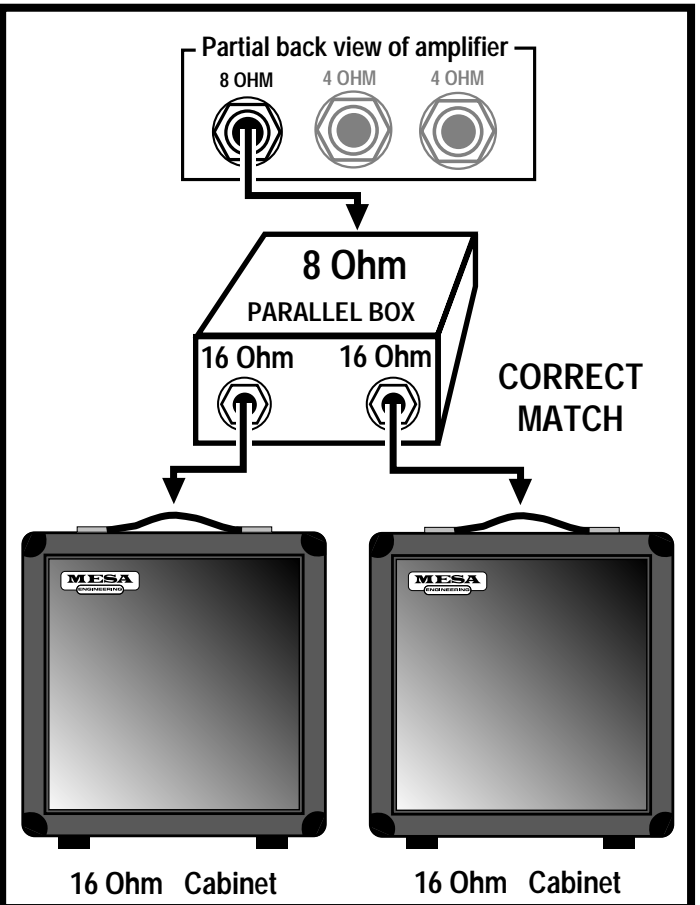
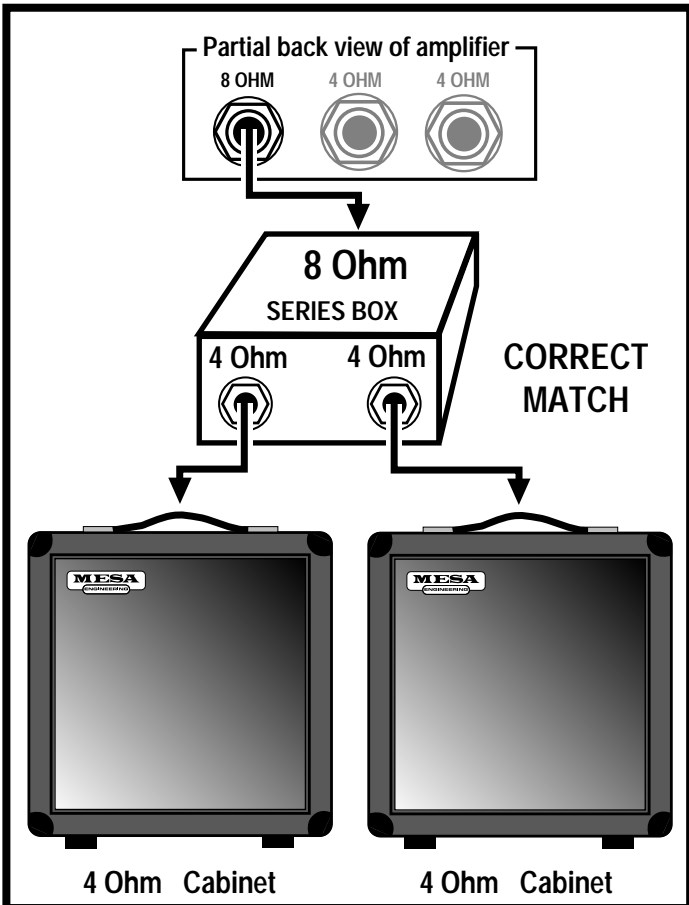

WIRING SCHEMES...Amplifier to Speaker Cabinets

10

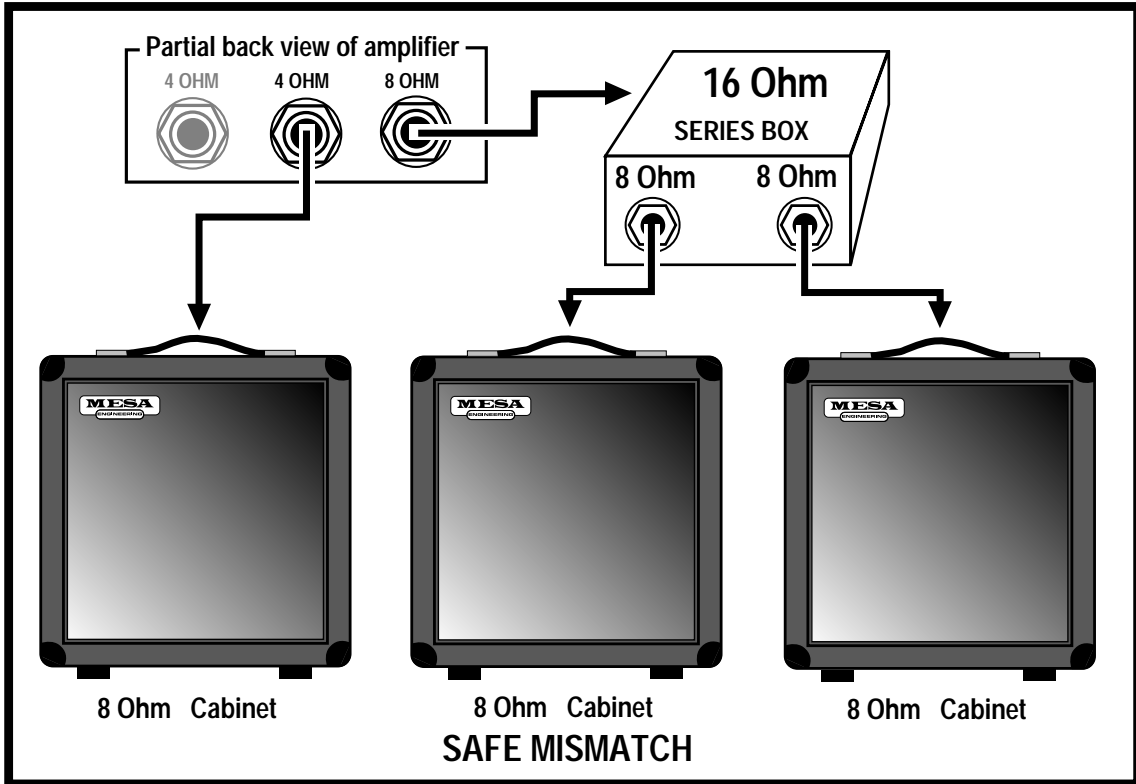

11

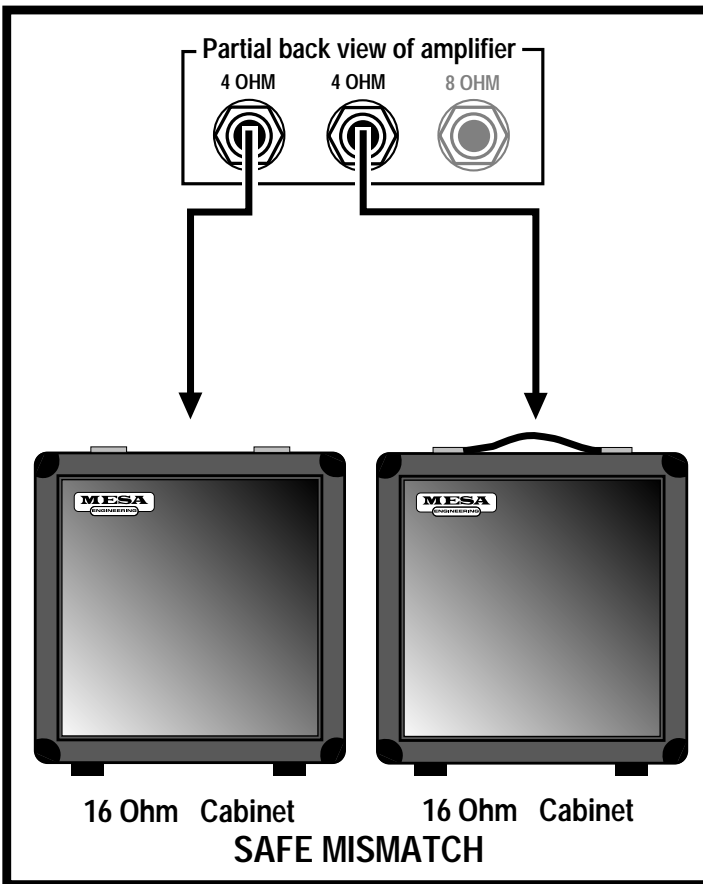

12

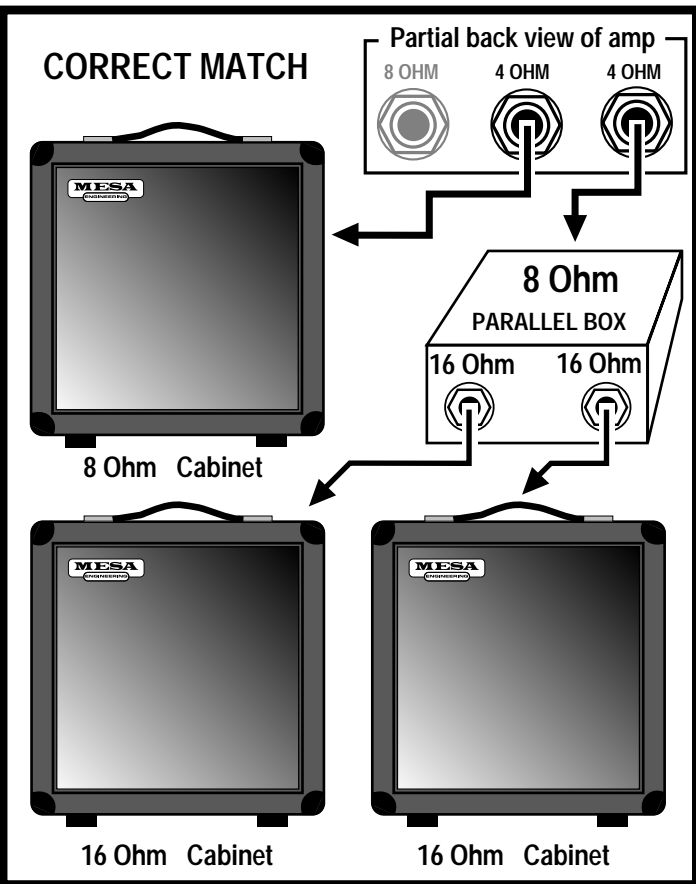

WIRING SCHEMES...Amplifier to Speaker Cabinets

13

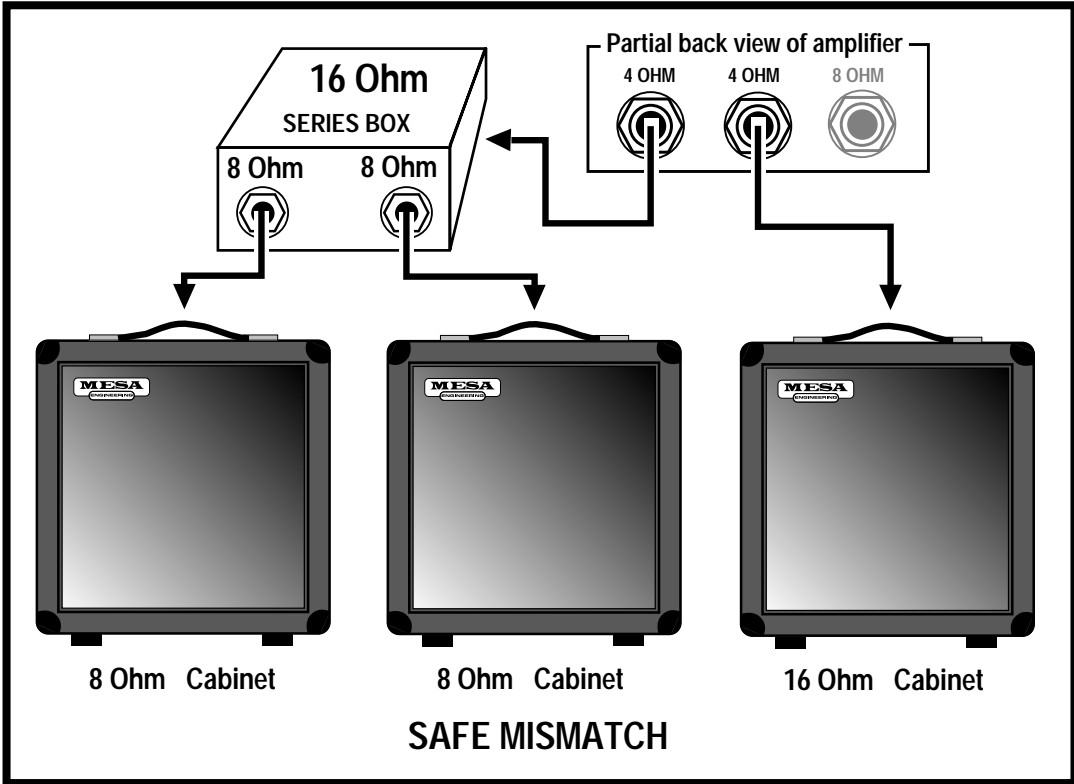

14

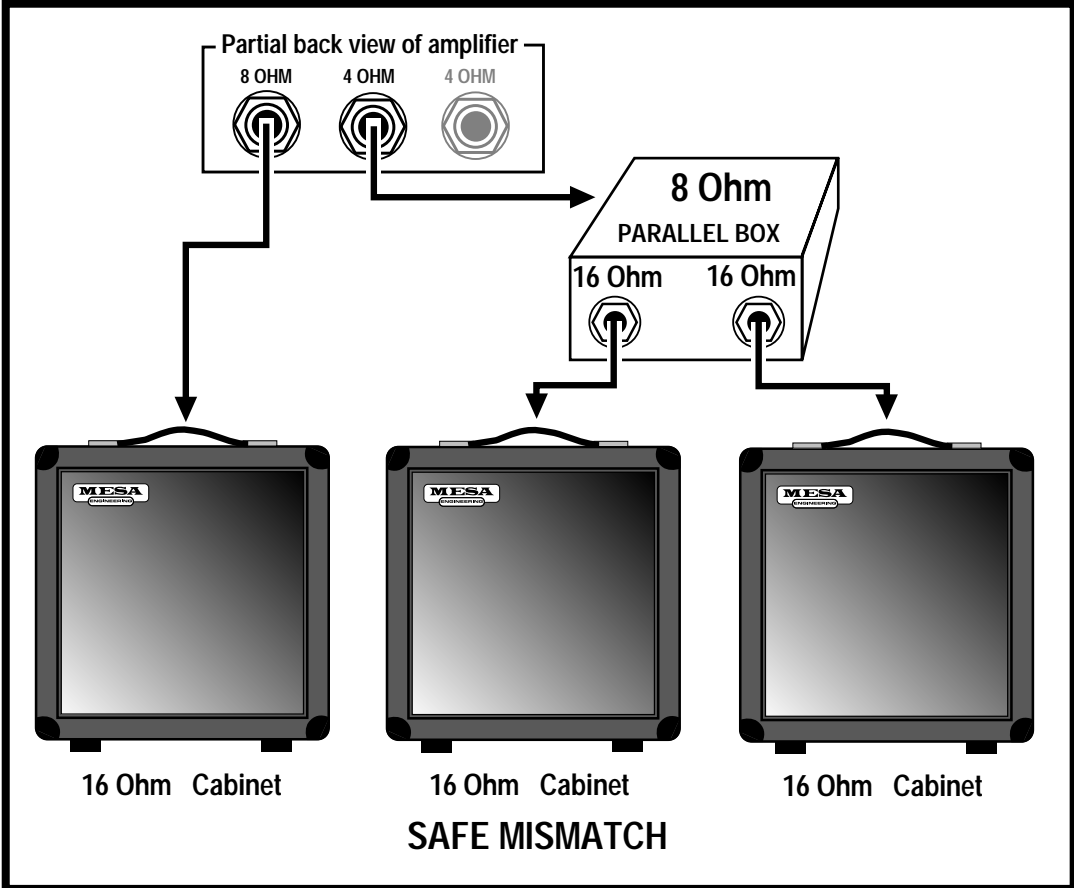

With apologies to Friends and Relatives from the Emerald Isle - who will make their appearance soon enough - the humor which follows is dedicated to the memories of Spec McAuliff and Fae (Rafael) McNally, two of the True Greats.

As their numerical references suggest, the terms Diode, Triode and Pentode indicate the number of elements within the vacuum tube i.e. two, three or five. All tubes also require a filament or heater which is not included in the count. Its purpose is to excite electrons from the cathode coating by raising the temperature such that they are able to boil out of the electron-rich coating material and form a cloud of free electrons in the vacuum space surrounding the cathode.

Although the term filament and heater are often used interchangeably, there are specific differences: A filament is a directly heated cathode where cathode coating is applied directly to the heating element. Examples are 5U4 twin diode rectifier and 300B triode amplifier tubes. A heater, on the other hand, is a heating element which is separate from the cathode and is usually inserted within the tubular cathode sleeve. Examples are 12AX7 twin triode amplifier and 6V6 or EL84 beam power pentode tubes. In all cases this fundamental aspect of each tube's construction is clearly visible, especially when the heating element is glowing red hot.

The cathode, then, would be considered the first numbered element because it is the source of the electrons. The word itself is from the Greek literally meaning completely down, which implies a sense of central origin - like the center of the earth where Tone begins. It might be said that an ecstatic audiophile experiences a positive catharsis, his soul being purified when his system transports him to Audio Nirvana. The only trouble with taking this positive imagery too far is that the cathode is, unfortunately, negative... at least electrically speaking. However this is easily remembered since virtually all musicians and audiophiles have also experienced the more common negative catharsis when they emerge from the emotional rebirth kicking and screaming in rage and frustration.

Once heated, the intrinsically negative electrons are energetic little fellows of almost no mass. Thus they may be accelerated almost instantaneously and will travel through a vacuum a nearly the speed of light. Being of like, negative charge, they tend to repel one another and thus within the electron cloud surrounding the cathode, there is much jostling and elbowing as each one tries to maintain his distance from all the others... unless there is a strong and universal attraction from an outside influence.

Visualize, if you will, a group of sub-atomic Irishmen milling about and in a repellent, negative state of mind. All are scowling and none wants to have anything to do with the other. Now introduce a strong attraction say, a public bar, and you can easily picture an orderly, if rapid movement of the lot in a single direction. This is what happens when a positively charged element called the anode or plate is introduced into the vacuum.

The plate is the large metal element most prominently visible through the glass of an electron tube. It is the outermost element of a tube's structure and it surrounds all the others. The cathode is at the center radiating electrons outwards. As higher and higher positive voltage is applied to the plate, the attraction for the electrons surrounding the cathode is increased and with nothing standing in the way, full uninhibited flow to the plate occurs... sort of like removing the doors and offering free drinks to the crowd of surly Irishmen milling around outside. As electrons flow to the plate, the space charge will continually be replenished by further 'boiling' of the hot, electron-rich cathode as you can easily imagine other Irishmen impatiently taking up the places of those who've gone inside - until the entire village is deserted.

Now, where do they come from and how do they emerge? Well, a grand and elegant lady once showed me how to revive flat champagne: She dropped a raisin into the glass. There was a dramatic and immediate increase in effervescence with the introduction of a cathoding surface. Thousands of tiny bubbles suddenly appeared - and continued to flow from the raisin. Of course the bubbles were made up of gas dissolved in the beverage, but the analogy makes it easy to visualize the loosely bound electrons dissolved in the rich cathode coating as they effervesce from its heated surface.

But back to the electron flow. If the electrons are strongly attracted to a positively charged plate, then it follows that they are strongly repelled by a negatively charged plate and they are. Thus, if an alternating current - such as comes from a transformer - is applied to the plate, electrons will flow only during the times when the plate is positively charged. During periods of negative plate charge, electron flow is stopped and the space charge of electrons remains compressed in the area around the cathode.

ON TRIODES, PENTODES & IRISHMEN: (Continued)

Thus a diode tube - one with a cathode and an anode - is mostly used to rectify alternating current into direct current by passing it without restriction, but in one direction only. This also explains why closing time is strictly enforced at Irish pubs: During normal operation, the traffic flow is similarly unimpeded and uni-directional toward the bar and this process rectifies the work-day negativity. It goes without saying that no one leaves as long as the atmosphere around the bar remains positively charged.

TRIODES: This section is a continuing technical treatise on the workings of Irish Pubs but to make it easier for the layman to understand, it is explained in terms of vacuum tube technology. Enter the original bar - free beer and no doors. Well, it turns out that some control over the flow can be a necessary and useful advantage. This led to the invention of those swinging louvered saloon doors which are open at the top and bottom. They are patterned after the control grid of the vacuum tube, which is a loosely wound coil of thin wire located between the cathode and the plate.

In a Triode the plate is always positively charged with high voltage D.C. and even though the grid is blocking the path, those negative electrons can still FEEL the strong attraction - just as the Irishmen can see in through the louvers of the bar doors. They know what pleasures lie beyond, but to get there requires overcoming the negative influences controlling the access. This negative influence is typically called a Bias. In electronic terms that means the grid is supplied with a voltage which is slightly MORE NEGATIVE than the already negative electrons. The more negative the Bias, the more it tends to neutralize the attraction of the plate and repel the electrons back toward the cathode.

The Irish can be similarly charged with Bias, but unless you are Irish yourself, this type of Biasing may be more difficult to understand. The effect is similar though: The more negative the Bias, the more it impedes forward progress. Generally speaking though, the electronic Bias of the grid is easiest to overcome, and for two main reasons: First, the Bias is set - like the bar doors - to allow some passage. Second, the grid is mostly NOT THERE, like the louvered doors which are mostly open spaces. Unlike the plate which is solid, the grid is like a coiled bed spring. It can create a repelling field but mostly it's empty space in between widely separated windings of wire. It's very easy to control the electrons as they pass through the grid's force field: Changing the grid voltage only slightly will have an enormous effect on how much current flows through... and that's what AMPLIFICATION is: a small change in voltage at the grid causing a large change in current flowing to the plate.

The purpose of the louvered bar doors is similar to that of the grid, namely, to give momentary pause while still revealing the promise within. Hesitation mostly gives way to temptation, but there are those few stalwart Irishmen who think twice and decide to come back later. Most just pause slightly then go on through. That is the purpose of the bar doors: to prevent everyone from crowding in all at once - and as the door is made less of a barrier, wider spaces between the louvers, more of the bar's attractive influence is felt outside thus amplifying the customer flow and increasing the crowd at the bar.

PENTODES: Occasionally though, bar doors - even the louvered type - were found to be too effective, and too many customers turned away. Something further was needed to increase the attraction of the bar and overcome the resistance created by the door. Thus the cocktail waitress was invented.

Once again the idea was inspired by the vacuum tube. It had been discovered in some tubes, often large power types, that the distance to the plate was too great to attract enough electrons past the negative influence of the control grid. So another grid coil of fine wire was inserted between the first grid and the plate. This was called the screen grid and carrying a highly positive charge, it functioned as a "bait" for the plate.

In a properly designed power tube such as an EL84 or a 6V6, the windings of the screen grid are precisely aligned to fall in the shadow of the control grid. This way the electrons responding to the pull of the screen grid are lined up in sheets as they pass between windings of the inner control grid... only to find that they have been fooled! Once past the control grid and drawn toward the screen grid, they discover...there's almost nothing there. The path they're on has them aligned to zing straight through the spaces BETWEEN screen grid windings. So rather than a close and personal encounter, they just fly on past - and once they're out that far, there's no stopping them. The influence of the plate takes over and - being solid metal and of the highest positive attraction - it is at this final destination that the electrons congregate.

ON TRIODES, PENTODES & IRISHMEN: (*Continued*)

PENTODES: (Continued) Thus the proper cocktail waitress - visible through the louvers - is scantily clad so as to be all the more effective at reinforcing the attractive influence of her bar and by being located in between the door and the bar, she serves as bait to lure customers past the door's negative influence. Once through the door however, it is the rare Irishman who actually comes in personal contact with the cocktail waitress as, for all intents and purposes, she - like the screen grid - turns out to be a vanishing illusion. Yet, having come this far, the solid influence of the bar itself now takes over and attracts the customers to congregate, having happily reached their destination.

If you're still following this and haven't lost track of the count, you'll know we're still one element short of the five needed to make a Pentode. This last part is a pair of beam-confining shields which being negatively charged, serve to direct the flow right toward the plate. This is much the way a short entrance hall to the bar prevents wandering accidentally into the Men's room on the way.

Once at the bar though, the circuit is complete and the process of soul-nourishing works its ritual magic. Biases having been overcome, illusory nightingales having vanished, the spirits truly soar and the once surly Irishmen now are filled with warmth, wit and kindred friendship, enjoying the music and glowing nicely with their heaters on.

With appreciative thanks to the inhabitants of the Land of the Leprechaun, we have now concluded our little diversion into the mechanics of proper bar lay-out.

A feature article by Randall Smith
Designer / President

FRONT VIEW DUAL RECTIFIER

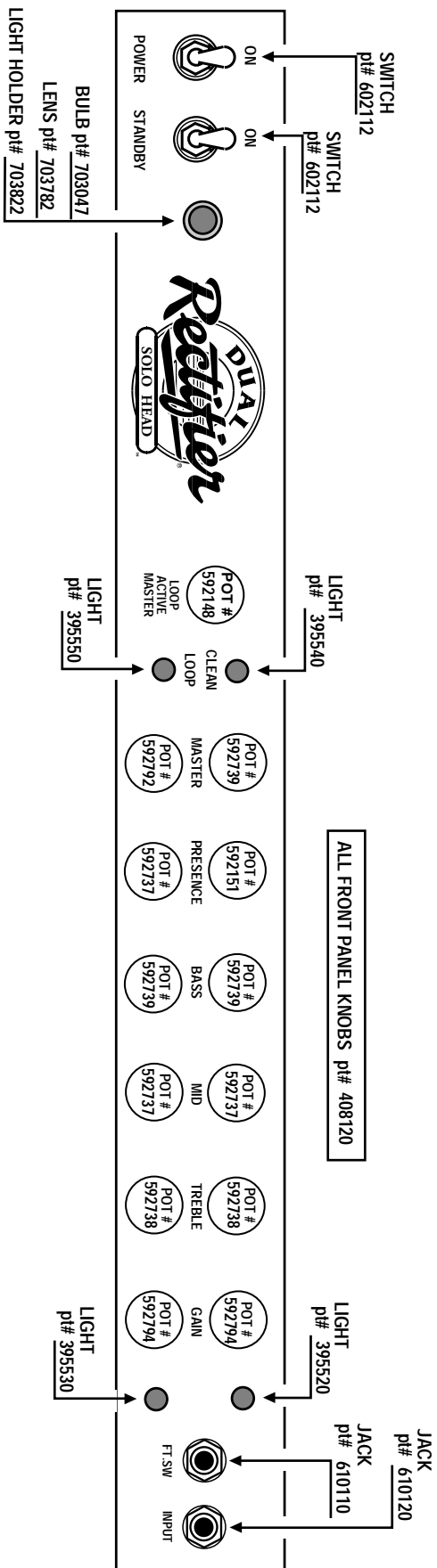

REAR VIEW DUAL RECTIFIER

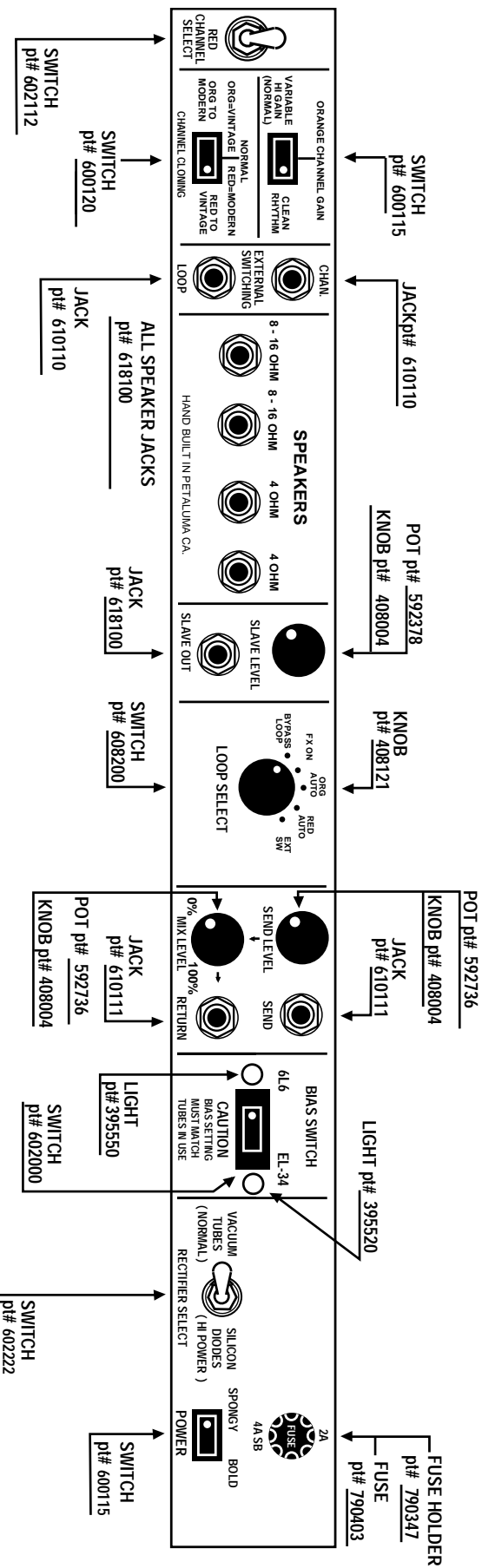

FRONT VIEW TRIPLE RECTIFIER

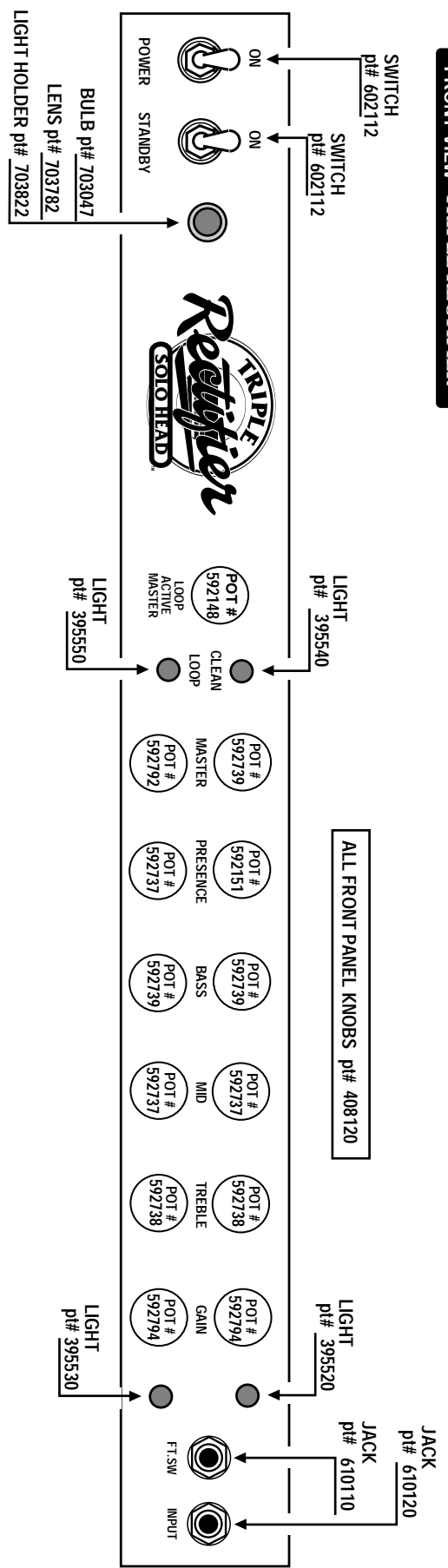

REAR VIEW TRIPLE RECTIFIER

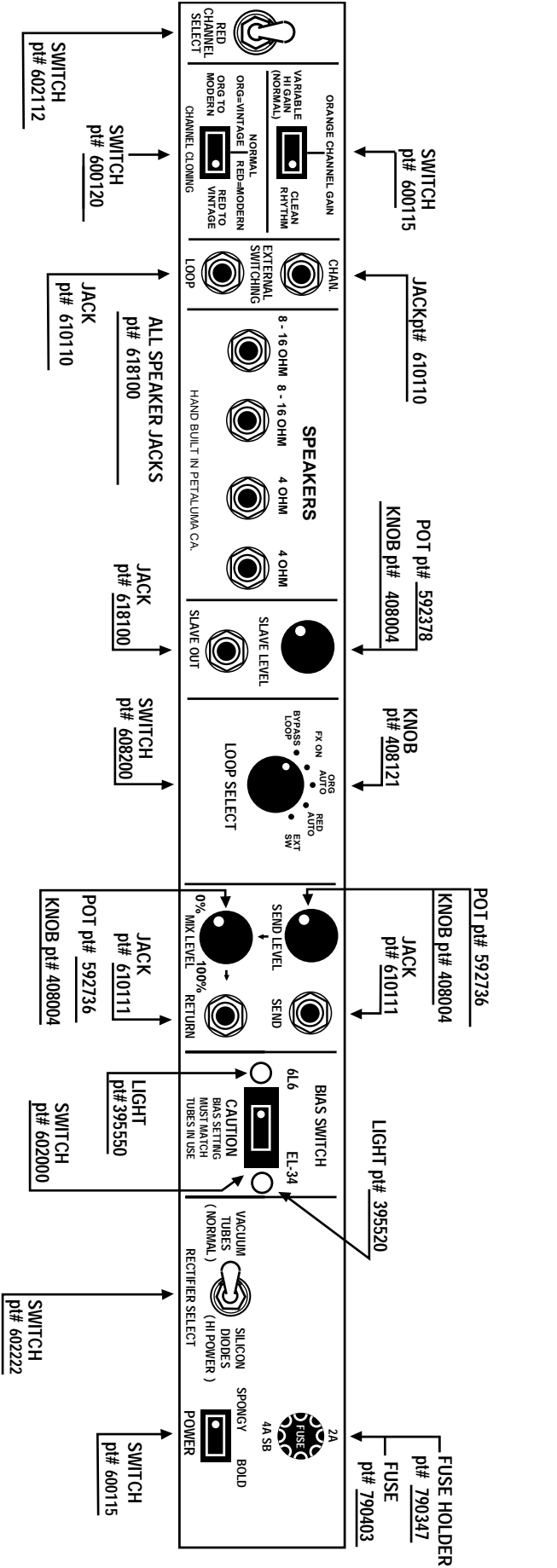

MESA/BOOGIE

The Spirit of Art in Technology

Thank you for trusting MESA/Boogie to be your amplifier company and we wish you many years of toneful enjoyment from this handbuilt all tube instrument.

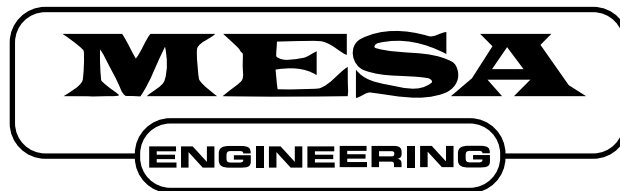

The Spirit of Art in Technology



(707) 778-6565 FAX NO. (707) 765-1503

1317 Ross Street Petaluma, CA 94954

USA